



## Chapter 2 - Construction

### In the Beginning....

It is desirable to read the entire construction chapter first before commencing work; sometimes an understanding of what is coming helps to determine the best way to carry out earlier work. So get reading, and you can get cutting styrene later.

When you receive your BBT chassis, we recommend you test out the unit, run it on your layouts and test stands, see that she runs as expected, understand the gearing and equalizing. It is better to get to know your chassis before building on top of it.

The construction demonstrated in these chapters is built from CAD drawing/templates, which were drawn before any construction of the elements began. In several cases, you might find the CAD template we're asking you to copy are ever so slightly different to the same component seen in my construction photos. The reason for this is that even the CAD templates have 'evolved'. I drew the templates first, then cut the styrene to copy the templates. In some instances, we've learned that there was an easier way to do something, and I thus changed the template after testing the construction. We've also discovered instances where the engineering drawings we're following are slightly different to what Mason actually built, and we've had to make a judgment call: do we stick to the engineering drawings, or do we follow the photographic evidence? Sometimes we've decided on the photographic evidence after attempting to build the same from the engineering drawing. Thus we've changed the CAD template after my modeling is already done. We're talking about such minor details, many may not even notice the difference, but we're aiming to build the most accurate model, which means matching engineering drawings, with existing photos, and working up the CAD templates to match our decisions.

## Painting the Model

At this time we ask that you review the color info provided in the 'Background' section, and take some time to think about how you'd like your Mason to look. Ultimately the color is up to you, and can choose to be as accurate as the historical data permits, or simply paint the loco in whatever colors you would like, to suit your RR etc.

Please note that no painting works will occur in this chapter. We will not actually start painting the model until a later chapter. I ask that you hold off painting till then, as more work is required on the chassis after this chapter, and to paint the model now will only hamper your efforts later. Take advantage of this delay, as it will give you time to really think about how you want your model to look.

## The Mason 2-8-6T Package

Folks who know me well, know I'm a bit of a push-over, especially when a steam locomotive is involved! Several folks have asked me for some guidance in building a South Park 2-8-6T version of the Mason Bogie, and a couple of people have ordered custom chassis' from BBT for such a loco. I had not intended covering the 2-8-6T in this class due to the work load of the other 6 Mason options we're building, but I thought it over, and I can offer a selected set of templates. In addition, the basic design and components are not that different to the 2-6-6T, only a bit larger! So this is the deal. In this chapter you can down load the 2-8-6T overall side profile drawing at 1:1 for the 1:20.3 scale model. In this chapter you can also down load the templates relevant to the works in this chapter. All other templates not included here for the 2-8-6T are to be based on the standard 2-6-6T templates. In advance we can tell you that the pilot template and cab templates are identical to the 2-6-6T, other templates only need stretching. I will not be covering the construction of the 2-8-6T in any more detail than that, but you will have sufficient info to build the model. I'd recommend this only to those who've built a model or two before, as much of it will require your clear head to know which bits to stretch, and which bits to use as-is. Throughout the project keep checking back to your overall 2-8-6T drawing in this chapter to compare lengths etc, to know what to stretch.

[Download the 2-8-6T templates here.](#)

The Chapter 2 Templates (2-6-6 & 0-6-6T)

[Download the all PDF files now for the 2-6-6T and 0-6-6T locomotives.](#) This set of drawings will be used throughout the chapter.

## Making the Pilot

For the pilot work you'll need to refer to the following drawings:

"Pilot Bottom Plate & Upper Beam"

"Pilot Spokes Template"

There are two options in building the pilot; both are shown on the Pilot Spokes Template:

1. The Mason Prototypical Template
2. The Wimp's Way Template

The difference between the two methods is only minor. The real Mason pilot has spokes with a leading edge that is angled. The angle begins flush with the upper beam and then slowly twists to a 45-degree angle near the bottom of the spoke, aligning with the pilot base. This will require that you carefully sand the leading edges of the spokes to simulate this twisting leading edge. The finished product is way cool, and is also prototypical.

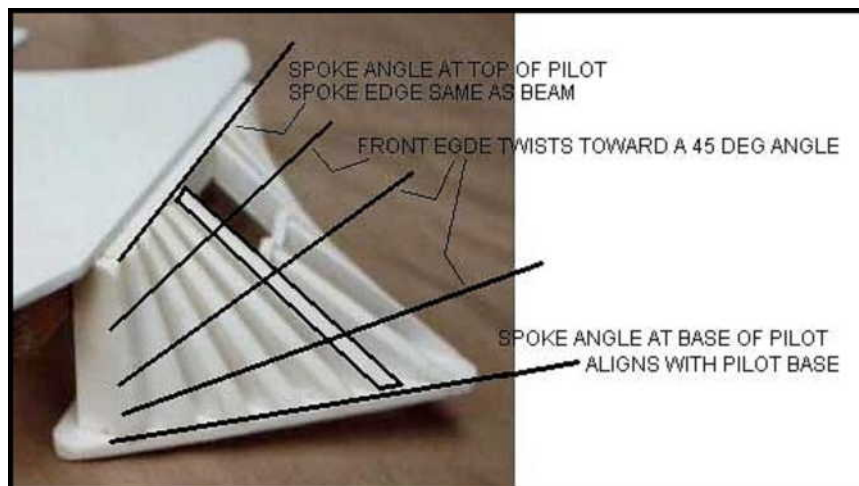

*Note the twisting lead edge to the pilot spokes on the prototypical pilot.*

The Wimp's Way pilot option is still a difficult pilot to make, but no sanding of the spoke leading edges is required. All the spokes are square edged. Ultimately the visual difference between the two ways is minimal. But it is the difference between being prototypical, and easier to build!

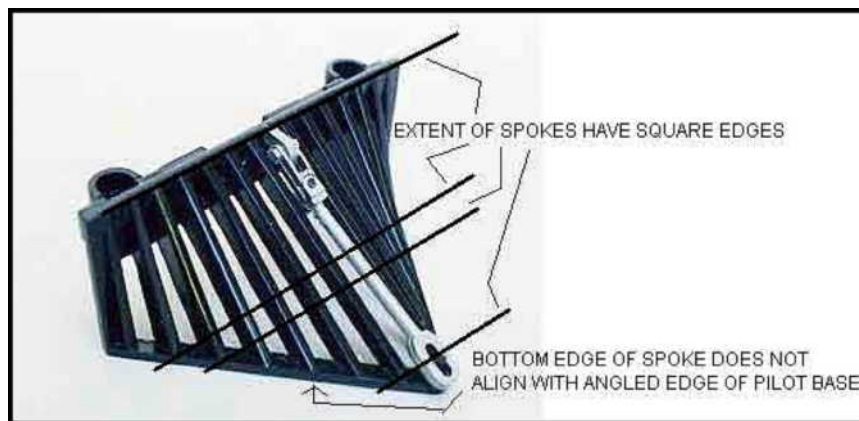

*The Wimp's Way pilot is similar to the above Bachmann 4-4-0 pilot.  
The spokes are square edged all the way from top to bottom.*

Choose which Pilot you're going to make, download the PDF and trace the entire CAD template onto 2.5mm thick styrene (or wood if you like).

The most efficient way to cut the pilot spokes out is to first cut out a long rectangle of **2.5mm thick styrene**, with the top and bottom of the rectangle matching the entire row of drawn spokes. Using a pin or similar sharp implement prick the corners of each spoke through the paper into the styrene. Get cutting! Remember to score about 50% through the sheet. Also be sure that you cut right through the styrene near the ends of the lines to be cut. Make sure the angles shown on the template are duplicated exactly.

Note the three holes shown on the pilot base. The holes are **1.5mm diameter**. The two holes on the sides of the base will be drilled and used by folks building the 0-6-6T Mason, or a 2-6-6T on min. 2.5ft radius curves. These people should ignore the 3rd hole shown at the tip of the pilot base. Those building the 2-6-6T and will be running this loco on 2ft curves, will only drill a single 1.5mm diameter hole at the tip of the pilot base.

Your cut parts should look like this:

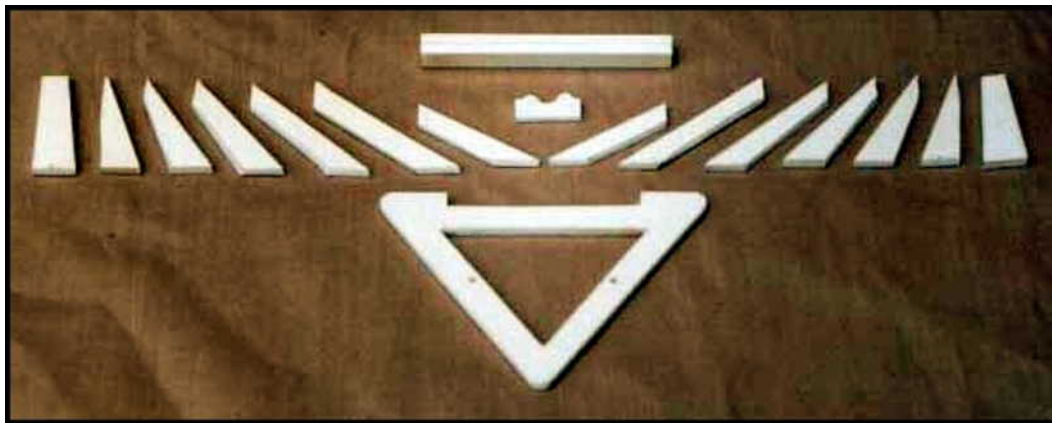

*The pilot base at bottom of picture, the LH and RH pilot spokes in picture centre, and Pilot upper beam made from two layers of 2.5mm styrene at top of picture.*

Once your pilot spokes are cut out, those building Wimp's way are ready to install their spokes on the pilot. Those building the prototypical pilot will need to sand the lead edge of each spoke. At the top end the spoke will remain square as cut, parallel to the pilot upper beam. At the lower end the spoke's leading edge is basically a 45 degree angle. Between the top and bottom end of the spoke, the lead edge is rotating from parallel to the pilot top beam to being parallel to the pilot base. The dotted line on the spokes of the CAD template indicates the location of the extent of the angled lead edge from minimal near the top to maximum near the bottom.

## **Step 1 - Setting out the Pilot Spokes**

You will notice the two middle pilot spokes are shorter than the rest. These centre two spokes do not extend to the top of the pilot, but are supported by a transverse brace mid way up the pilot. The transverse brace is that small part with two humps atop. Begin the pilot assembly by welding the transverse brace to the middle two spokes, and then carefully welding the two spokes down to the pilot base. **MAKE SURE YOU ATTACH THE ASSEMBLY CENTERED ABOUT THE PILOT BASE** thus:

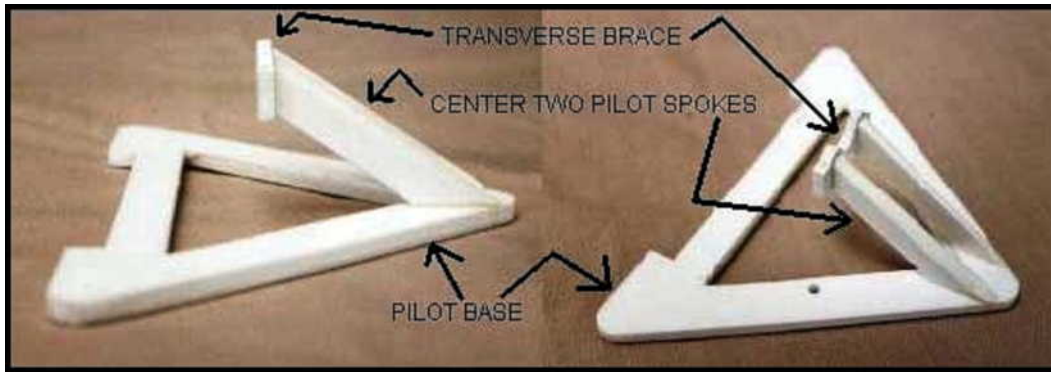

## Step 2 - Making the Pilot Top Beam

Copy the CAD templates, cut and laminate the two 2.5mm thick layers of upper beam together to form a 5mm thick chunk of styrene.

**Important Note.** You MUST decide now what sort of coupling you intend to use on your pilot. If a knuckle type coupler is intended, then this beam will have a 10mm chunk cut out of the middle of it, so that the coupler can reach back to the timber draw bar beyond. If building the original link and pin type coupler, with a coupler pocket and coupler pole, then only the outer layer of styrene to the beam will need a 10mm chunk removed from the middle. To the rear beam you will fix either a Coupler pocket casting (Such as an Ozark), or scratch make the pocket as shown in this chapter.

Attach the outermost pilot spokes to the sides of the upper pilot beam, and then attach the outermost spokes to the pilot base, aligning the leading edge of the spokes with the pilot base. The pilot base will extend behind the outer spokes. Make sure the distance between the centre and outer spokes is the same to both side of the pilot, i.e. symmetrical!

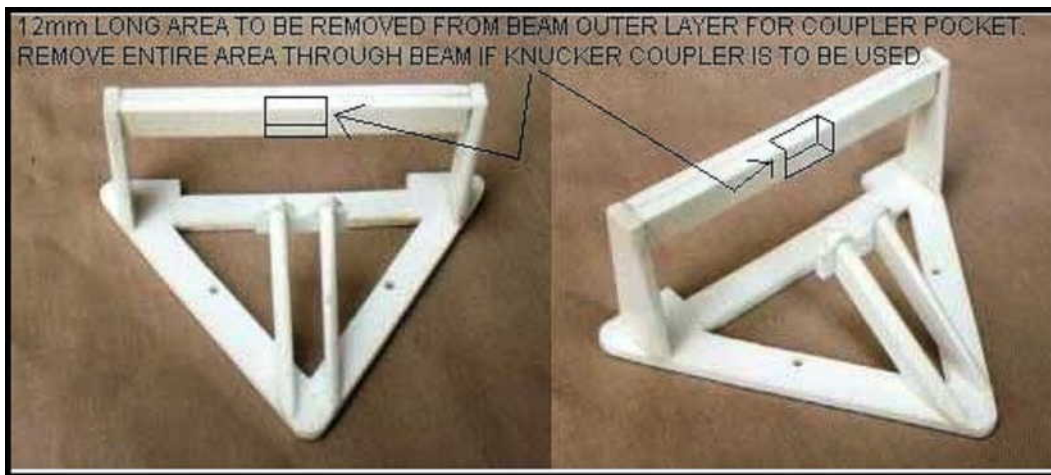

## Step 3 - Installing the Pilot Spokes

Using the center spokes as a guide, begin to insert the remaining spokes to the sides of the center spokes. Prototypically, the gap between the spokes is identical to the spoke thickness, i.e. the spokes are 2.5mm, and thus the gaps between the spokes are also 2.5mm. We use a scrap piece of styrene as a 'spacer' to help align the new spokes to the correct spacing. You would assume that one should use a 2.5mm thick styrene spacer as a guide to align the new spokes,



but when one takes into account the loose fit required to remove the spacer, it is better to use a piece of 2mm styrene. Insert the spacer with a loose fit, just resting on the spoke side, and slowly add each spoke to the pilot to both sides, working from the centre outward. The pilot spokes with temporary spacer is seen in these photos:

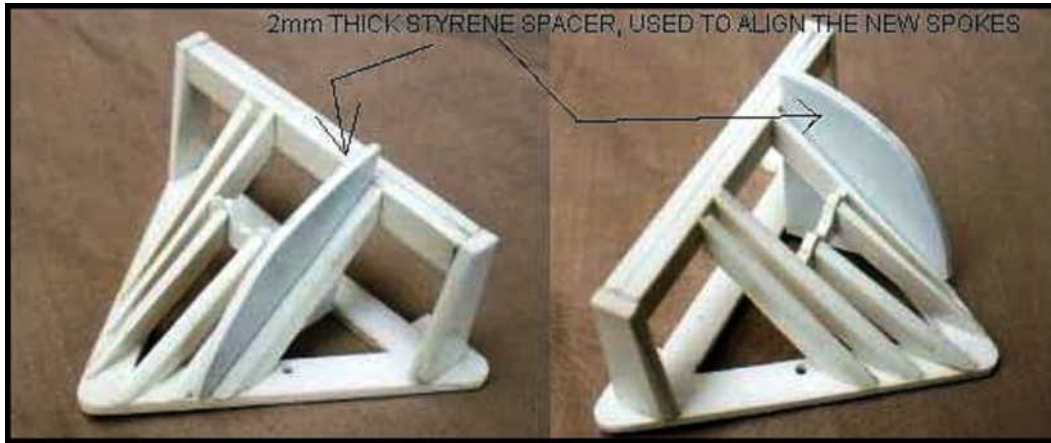

The finished Pilot will look like this:

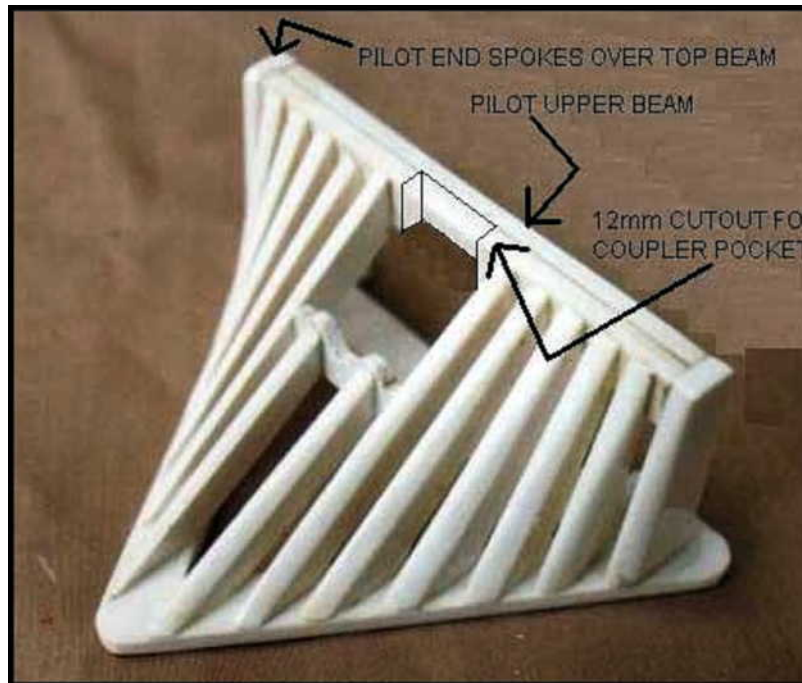

## Making the Pilot Deck

For making the pilot deck, you need to refer to the following Cad templates:

"Pilot Deck Construction"

"Pilot Draw Bar"

The hugest, most important, priority one, big time, bonanza, block-busting thing to note, and general safety tip is that the 0-6-6T and 2-6-6T types of Mason Bogies have different length Pilot decks! The pilot deck of the 2-6-6T is longer than that of the 0-6-6T. Thus make damn well sure you are tracing from the correct template; the 0-6-6 and 2-6-6T pilot deck templates are clearly marked.

The pilot deck is a fundamental part. The pilot deck will hold the cylinders and steam chests, and is also the part that supports the pilot/cowcatcher.

On the Mason model, there are 3 layers of styrene to be sandwiched together. The top 2mm thick layer is the visible part and the profile matches the 1878 pilot deck. The middle layer is also 2mm thick and is generally of simplified deck shape. The lower layer is only 1mm thick, used as a spacer to get the pilot deck to the right height above the rails, and also places the cylinder centre line at the right level.

## Step 1 - Pilot Deck Templates

Trace the PDF templates onto your styrene sheet. Two parts onto the 2mm thickness and one part on the 1mm thickness. Cut the parts out. Drill the holes as shown. These holes are used to fix the cylinders to the deck, and fix the entire assembly to the locomotive chassis. The 2mm thick upper most deck part and pilot seen in this photo:

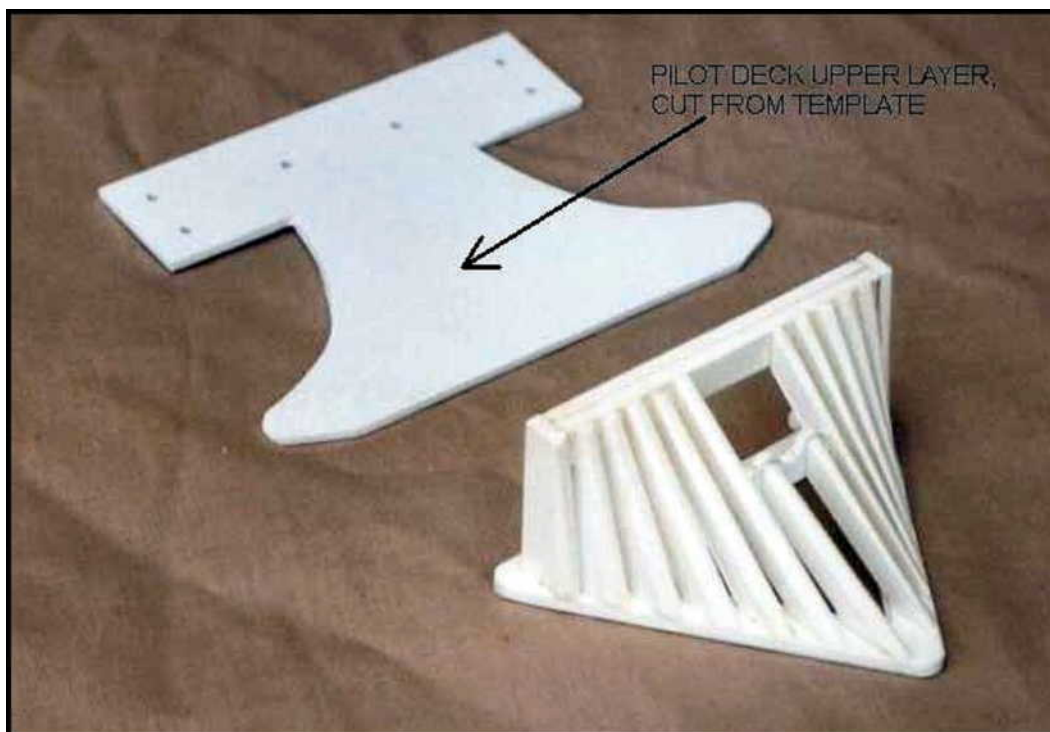

Note that the pilot template has changed slightly from this photo! The form seen in this photo reflects the profile seen in the Mason engineering drawings. After considerable investigation of photographs, its been revealed that the deck was built differently to this. Thus we have changed the leading edge of the deck to suit the 'as built' practice. You will see the change flow through in later photos of the model.

## Step 2 - Making the Timber Draw Bar

You'll need to obtain a 9mm X 9mm timber square section rod. You can get these as hardwood rods at the local hardware store. This rod will form the timber draw bar of the pilot. Cut the to length shown in the CAD template. Round off the ends of the draw bar to match the top deck profile. Note this beam will end 0.5mm shy of the actual profile of the upper deck.

Using 5min epoxy, bond the draw beam to the pilot deck underside in the location shown in the template; this will be 5mm inboard from the leading edge of the pilot deck. We will apply some bolts later that fix the timber beam to the deck. While my photos do not show it here, it is a good idea to remove a 50mm long, by 4mm wide chunk out of the bottom of the timber draw bar. This will enable the pilot wheels of the 2-6-6T types to run under the beam on tight curves. On the 0-6-6T types, this step is not required.

You might also like to take a whole section out of the draw bar so that Kadee coupler boxes or other forms of knuckle coupler can be surface mounted under the pilot deck. We'll leave that to you. In this chapter we demonstrate how to make the prototypically correct link and pin type coupler on the pilot.

### Step 3 - Assembling the Pilot Deck

Mark out the exact centre line of the top deck, and the centre line of the pilot, and then fix the pilot/cow catcher assembly to the dead centre of the timber draw bar. Use 5min epoxy to bond the pilot to the draw bar. When the glue has dried, you have the option of screw fixing the pilot to the draw bar as well. Prototypically there were two bolts that ran through the pilot upper beam into the timber draw bar, one bolt to each side. The bolts were hidden in the upper beam, between the last and 2nd last pilot spoke to both sides. I'd use one of your smaller (10BA or 1-72) bolts in this area (12mm long). The finished pilot deck, draw beam and pilot attachment will look like this:

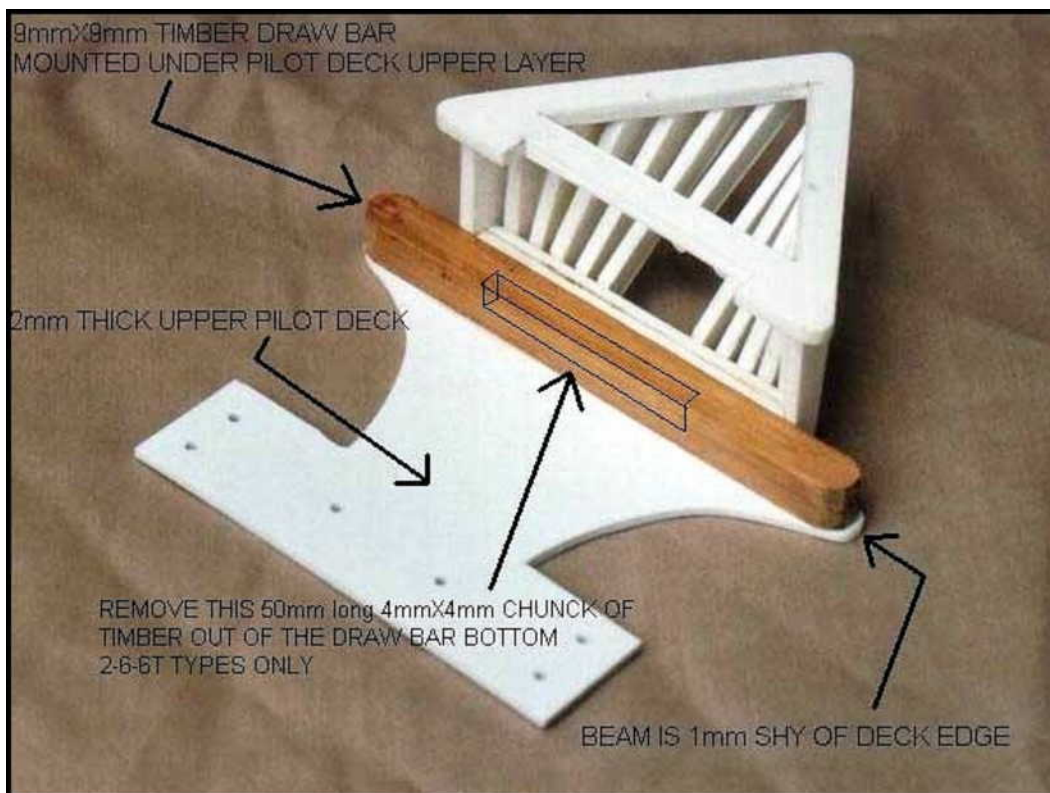



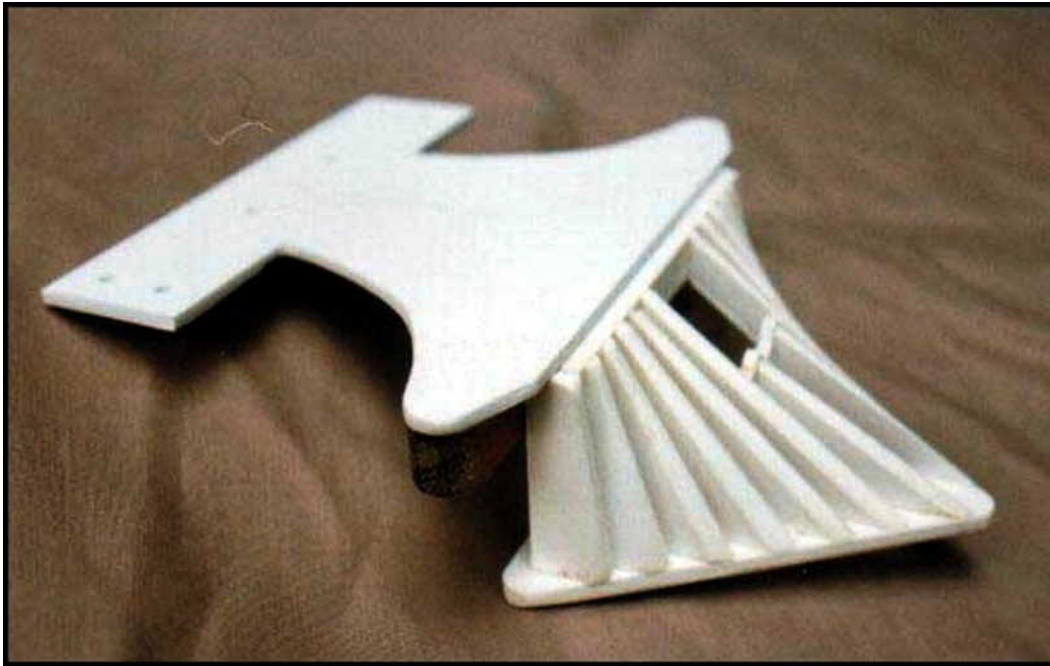

The Pilot and deck seen from above. Note how the top deck's leading edge overhangs half the thickness of the pilot's upper beam. The timber draw bar is set 2.5mm back from the deck's leading edge.

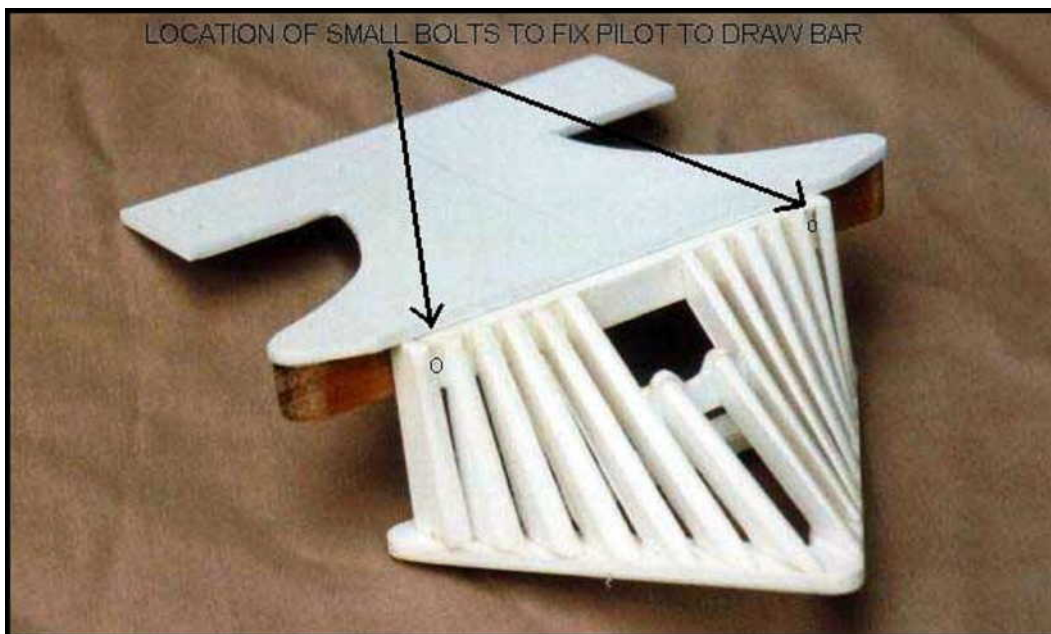

#### **Step 4 - Adding the Pilot Deck Layers**

Install the pilot deck middle layer (2mm thick) and lower layer (1mm thick) so they butt up to the timber draw bar. Cut a 3mm wide, 120mm long strip of 0.5mm styrene sheet. Weld these strips under the pilot deck, providing a fascia over the 3mm thickness of packing under the pilot top deck. The deck should look something like this:

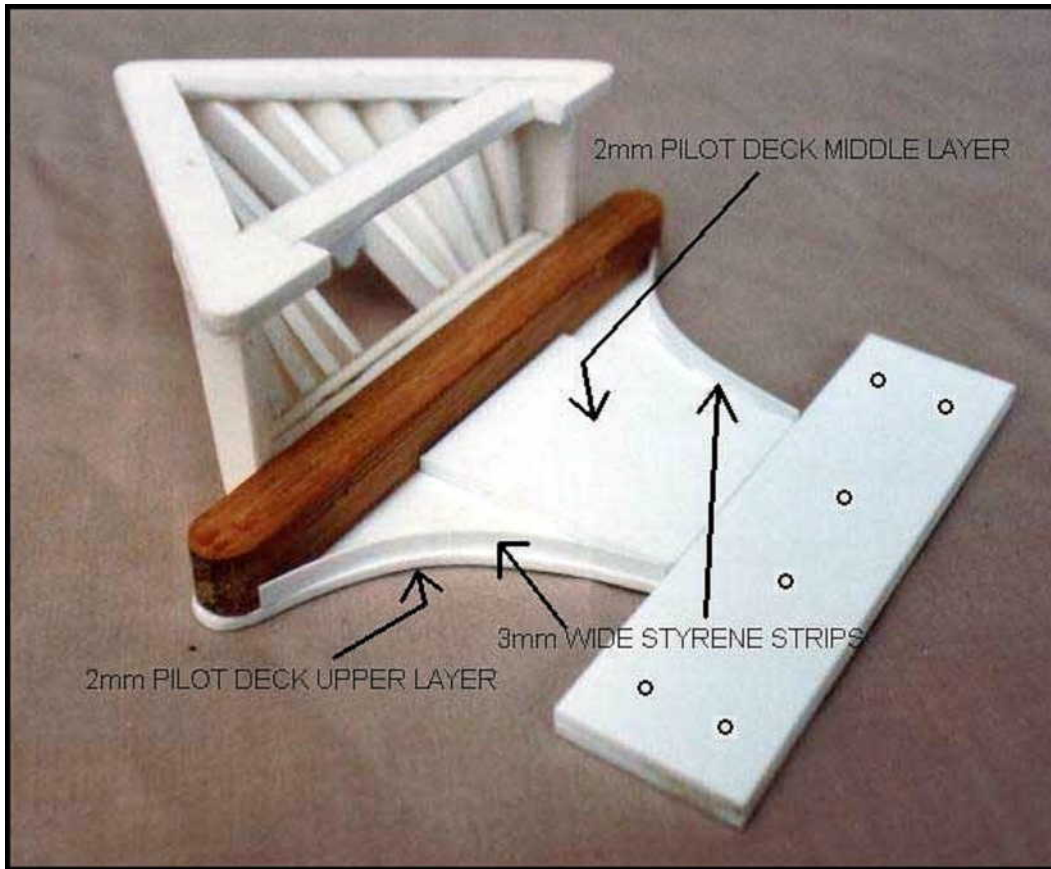

## Making the Locomotive Cylinders and Steam Chests

Now we start to see some form! Jolly Good show chaps! Refer to the CAD templates entitled:  
 "Cylinder & Steam Chest Templates"

### Step 1 - Making the Cylinders

Go out into the world and hunt for some 22mm diameter PVC pipes. These pipes will form your cylinders. Generally you'll find the standard PVC pipes either too large to too small. The perfect size can be obtained by using the PVC joining pipes used to join two smaller pipes together. Look in the Hardware stores, or electrician's stores for these 22mm diameter joiners. The 22mm is measured as the outside diameter. The ones shown in the photos here were PVC electrical conduit joiners. Try very hard to get these pipes in 22mm diameter -- smaller or larger will not only be un-prototypical, but would cause the centerline of the cylinders to be out of line relative to the drive wheel centers.

### Step 2 - Cutting the Cylinder Pipes

Cut two 31mm lengths of the PVC pipe. Be sure not to cut the pipe so much as 1mm longer, or your pilot wheels will hit the cylinder heads on sharp curves! To cut PVC pipe 'square'... mmm that's not a good word to use...in order that you cut the pipe straight, and not crooked; a technique is to wrap a length of masking tape around the pipe. If you wrap the tape off-line, the tape will not match up with itself after wrapping right round the pipe. If the tape is correctly wrapped around the pipe, the tape ends will join perfectly. Use the edge of the tape as a cutting -

line, cut along the edge of the tape and you'll cut the pipe straight. Once the pipe is cut, roll it along the bench top and watch the cut end as the pipe rolls. If you've cut 'square' the pipe end will just rotate. If the pipe is not cut square, the end will appear to wobble like a buckled wheel. Try a little sanding, and slowly bring that wobble to a smooth ride.

Next cut some rough 25mmx25mm squares of 1mm styrene, and attach these patches to both ends of the open pipes using 5 min. epoxy.

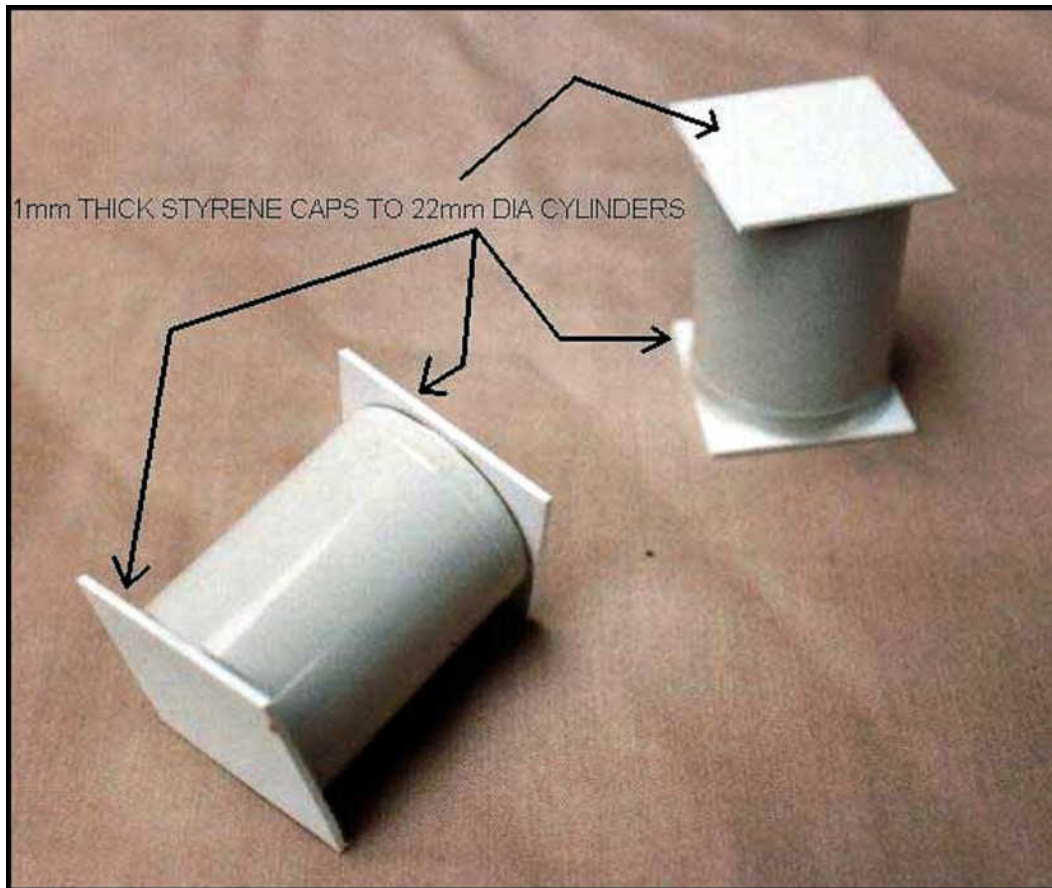

When the glue has hardened, using either scissors or a knife, trim around the pipes, cutting off the excess styrene from the caps such that the caps are now also 22mm in diameter.

### Step 3 - Making the Cylinder Caps

Cut a 3mm wide strip out of your 0.5mm thick styrene sheet. You'll need about a 270mm length in total. Using Super Glue, wrap this 3mm strip around all 4-cylinder ends, making sure you start and end the strips on the same side of the cylinders -- you want to hide these joints when the cylinders are fixed to the loco. When the strips have hardened into place, carefully sand the edges of the cylinders such that the joint between the 3mm strips and the end caps is rounded off.



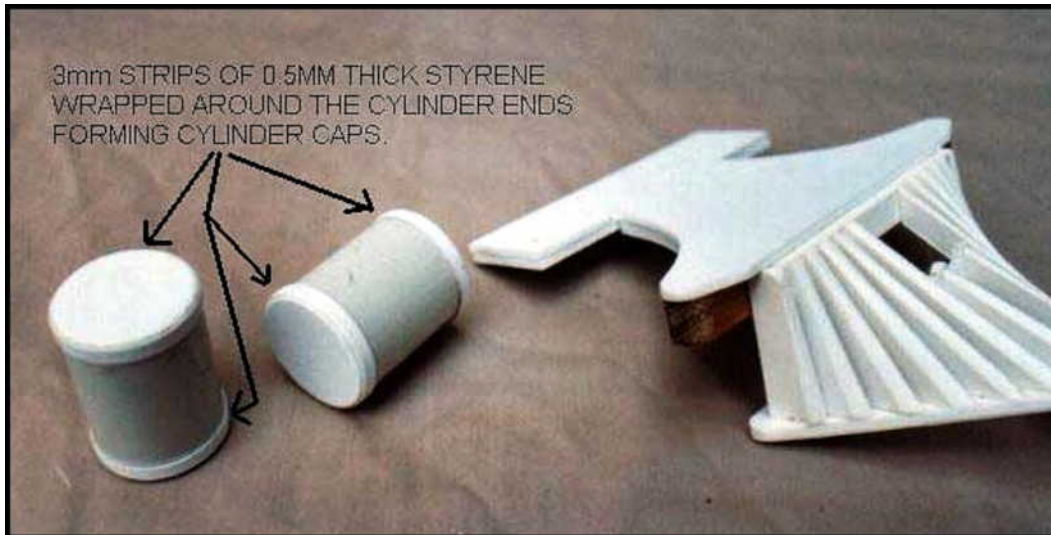

#### Step 4 - Attaching the Cylinders to the Pilot Deck

Using 5min epoxy, bond the cylinders to the pilot deck. Make sure the cylinders are placed exactly in line with your two bolt holes on the deck, and central about the holes. The hole locations are marked on the CAD template. Be sure to get the holes located accurately; absolutely 79mm apart as indicated on the drawing, as these holes are the position of the cylinder centre line. If you mount your cylinders closer together than the 79mm, you run the risk of the drive wheels hitting the cylinder heads. Its also likely that the side rods will clash with the piston crossheads. Make sure the joins in the 3mm capping strips are facing inward, out of sight. Also make sure the cylinders are absolutely parallel with the pilot deck centerline.

It is some trick to ensure that the cylinders are exactly parallel with each other and aligned properly with the deck. You should be able to locate the two holes for each cylinder accurately on your styrene deck plate. Use a ruler to check the holes are laid out parallel with the deck sides, and parallel with each other.

There are different ways to find and draw a line along the side of a cylinder that is exactly parallel with the cylinder itself. One way is to lay your cylinder flat on a tabletop. Where the curved cylinder surface touches the table top will be a line parallel to the cylinder. If you mark both ends of the cylinder at the point where the pipe touched the table and then draw a line between the marks you'll have a pretty good pencil line that is parallel to the cylinder...you might need to use a magnifying glass to see exactly where the pipe touched the table top, oh and when marking the pipe ends, make sure you don't roll the pipe at all...tape it down if you have to.

Another way is to place the cylinder on end, on a perfectly horizontal bench top, right near the edge of the bench. Use a spirit level to check the bench top is level. Also be sure the end of your cylinder is cut square so that the pipe sits perfectly vertical off the bench top. Next get a 2ft length of cotton thread, tie a weight to the end - a rusty nail or a doorknob will do. You have just made a 'plumb bob'. Now gravity will tell you what a vertical line is. Hold the end of the thread over the top of your cylinder, with the rest dangling vertical down the side of the cylinder, down past the edge of the bench. When the plumb bob stops swinging, you will see a vertical line that will be parallel to the pipe.



Once you're confident that you have a drawn line on the cylinder that is parallel to the cylinder, and your deck plate has the holes drilled accurately, you need only place the cylinder against the deck. Look through the holes, and match up the pencil line seen through the holes. The cylinders and deck will now be aligned. Use a couple of dabs of epoxy to hold the cylinders in place, and allow the glue to harden.

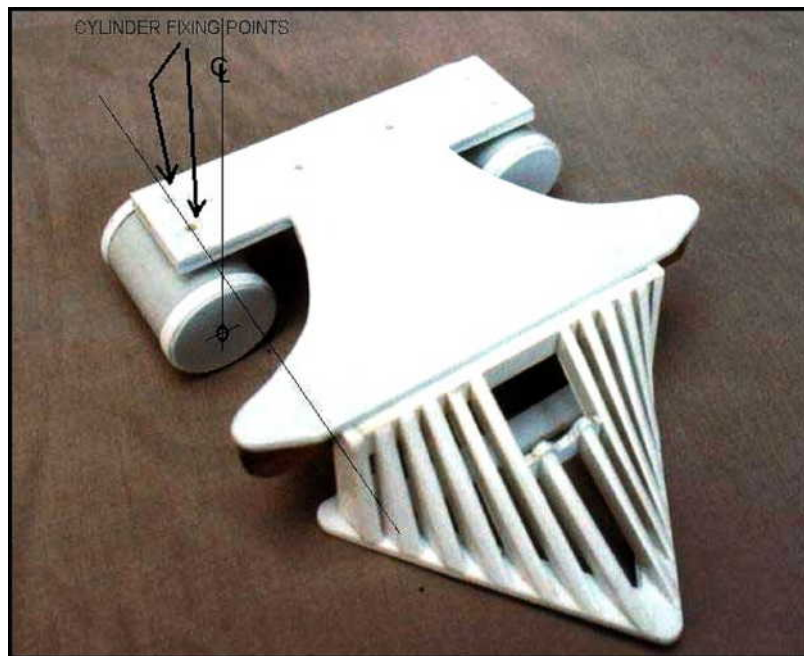

### Step 5 - Screw Fixing the Cylinders to the Deck

When the glue has hardened, and you are happy that the cylinders are exactly centered to the holes in the pilot deck, then drill through the pilot deck holes into the cylinders. Using the larger 8BA or 2-56 bolts, insert 4 bolts of about 6mm (1/4") long into the cylinders mechanically fixing the cylinders to the deck. Do not use longer bolts or they might hit the pistons when the loco is running.



## Step 6 - Making the Steam Chests

On the Cylinders & Steam Chest Template drawing, you will find the steam chest profiles and the front and back walls to the interface between cylinder and steam chest. Trace and cut out in the thickness indicated (1mm styrene for the steam chest walls, and 2mm for the steam chest caps).

Assemble the steam chests as small boxes on your work bench, four 1mm walls with the 2mm plate on top. The vertical joints in the box sides should be facing forward and reward only, with no joints visible from the sides. Assemble using welder cement. The 2mm thick top should overhang the steam chest sides by about 0.5mm. Carefully sand and round off the 2mm thick top edges and corners of the steam chest top. Next weld these steam chest boxes to the pilot top deck so the boxes align with the outer edges of the deck profile above the cylinders. Next install the interface cladding to the front, back and sides of the cylinders. Weld into place. The interface cladding top edge should be in line with the base of the steam chest boxes.

Now its time to install the whole pilot unit onto the chassis. Do not worry if you don't have your BBT chassis yet, you can install the deck later. The two holes on the top of the pilot deck should align with the two holes provided on the BBT chassis in front of the lead driving wheels. It's best that the holes to the top deck be a loose fit in relation to the bolts that thread into the chassis. You might like to be able to move the deck about a bit to fine tune the position and then tighten down once happy.

### Things to look for to align the pilot deck:

Check the pilot wheels of the 2-6-6T do not bind with the cylinder caps when running a 2ft curve. Check the cylinder caps on the rear do not bind with the drive wheels. Also see that the pilot is not moved back too far or the pilot wheels will bind with the timber draw bar.

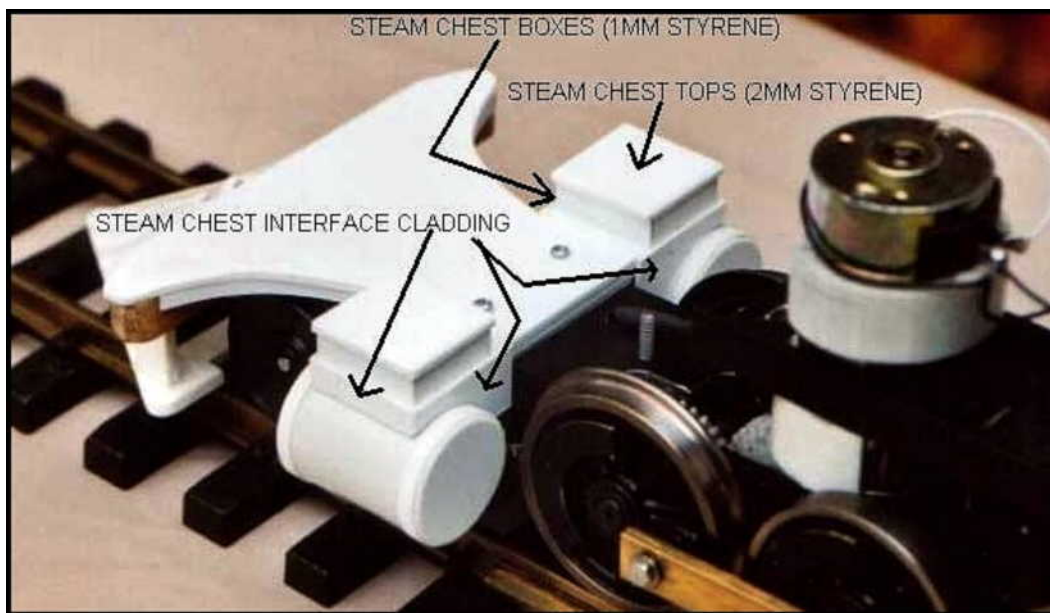

*The above image shows the pilot deck properly located onto the chassis.*

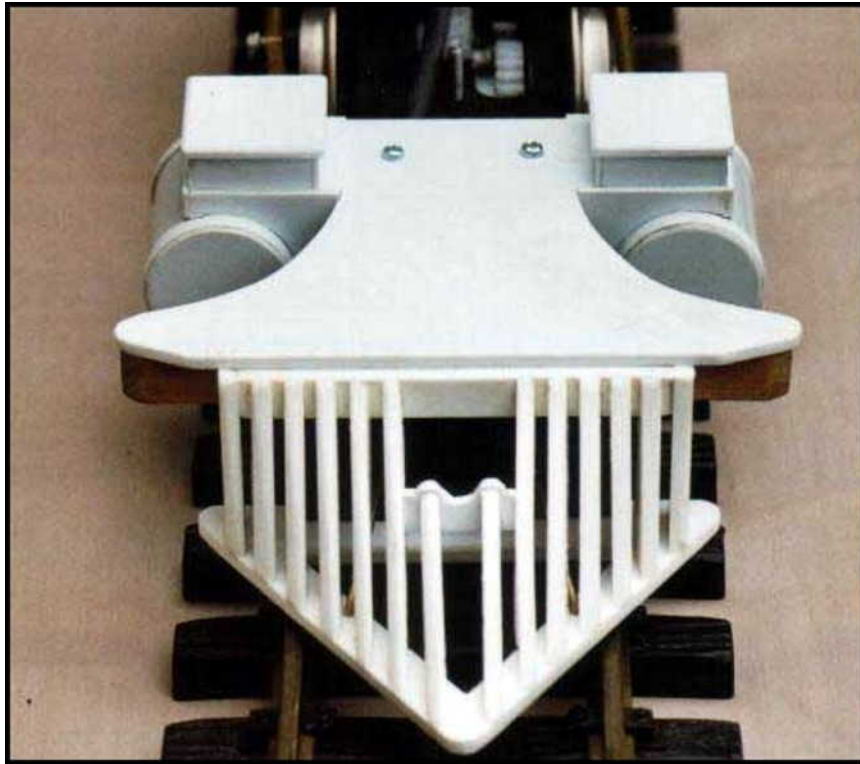

### **Step 7 - Applying the rivet details to the Pilot Deck**

Now we begin some rivet detailing. The same principle will be used for much of the rivet detailing on this model, but other methods can be used, such as real bolt heads (no washers) for larger bolts and pinheads for smaller rivets. I'll be demonstrating this detail using styrene.

In our parts list, we asked for Evergreen strips, of 0.020x0.040 size. These are our SMALL Rivet sticks. We also have some Evergreen 1.5mm diameter styrene rods, these are our LARGE rivet sticks.

To represent the prototypical bolts on the pilot deck, we use our Evergreen 1.5mm styrene rods. OK time to take out the LARGE Rivet stick -- hit me, hit me, hit me with your Rivet stick...HIT ME!! Cut Ten 1mm long slivers of the 1.5mm dia. rod, and weld into place as shown in the diagram and photo (refer cad drawing 'Rock Guard Views for bolt locations'). This is the only expressed fixing seen on the prototype, no exposed threads, washers or other rivets! Mason ran a tight ship when it came to detailing, and thus many of the locomotive's fixings were concealed.

You may choose to insert 4 real brass bolts over the pilot draw bar area, in lieu of the styrene. You may do so, using 4 brass 6mm long 10BA or 1-72 bolts. Bolt them right down into the timber, thus fixing the draw bar as well. Only do this if you know you can make those bolt heads a neat 1.5mm in diameter. Later in the chapter we will bolt fix the draw bar in a more concealed way.

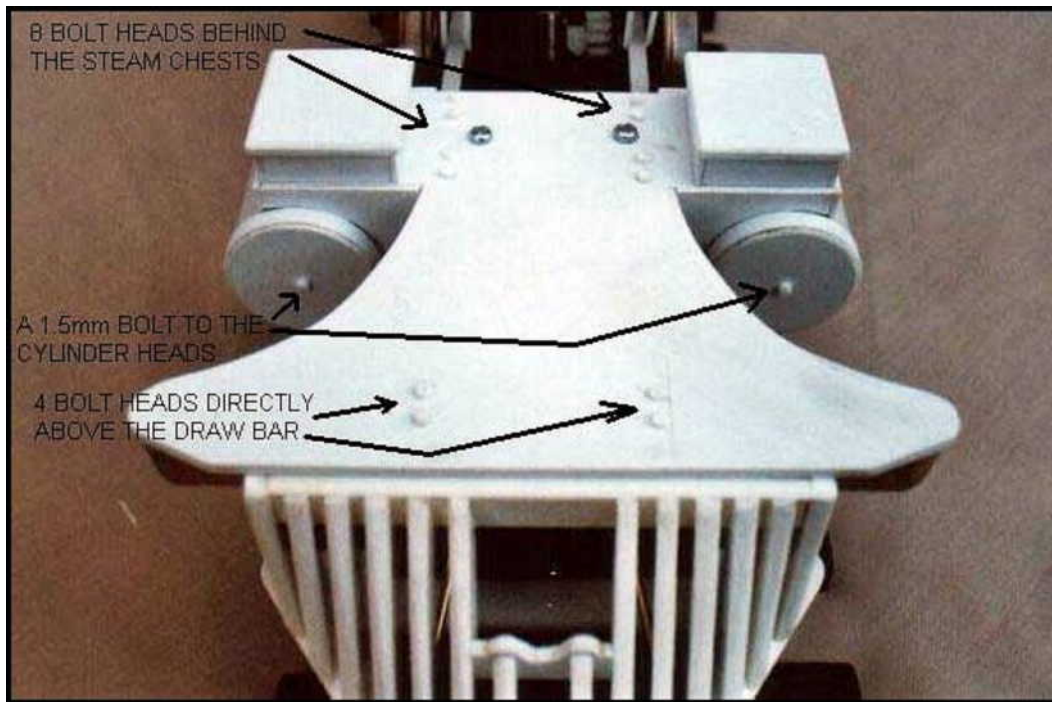

## The Pilot Braces

The pilot braces were rods of iron that ran diagonally down from the base of the cylinder saddle to the base of the pilot. They form diagonal bracing that strengthens the pilot against frontal impact. These braces were common place on real locomotives, but usually ignored on models, because they are generally out of sight. Our scratch made styrene pilot has the potential to be fragile. However, having now made this pilot, I've found it is remarkably strong! The addition of prototypical Mason pilot braces will go a long way to protect your model from damage due to frontal impact

If you are building the components of this chapter without the BBT drive at this time (you may be awaiting your order), you will not build this step just yet. Put this simple work aside and try not to forget to add it when you do have your drive unit!

On the lead end of the BBT chassis, you will notice 3 tiny 1.5mm holes. On the pilot base template you will also notice 3 tiny 1.5mm holes. Two holes are seen mid way along the pilot base diagonal; the 3rd hole is at the tip of the base plate.

Your mission, should you choose to accept it, is to install diagonal lengths of 1.5mm brass rod between the holes in the BBT chassis, and the corresponding holes in the pilot base, BUT we do not use all the holes at the same time!

### Pilot Braces for 2-6-6T locos Running on 2.5ft Curves or Wider

If you are running your Mason on rails with 'fairlie' wide curves, down to a minimum of 2.5ft radius (LGB 1500 curve), then you'll be installing two braces, and following prototype practice. Install only two 1.5mm brass rods between the two outer holes on the BBT drive, and the two holes found on the diagonal sides of the pilot base. You install the braces by making the brace of the correct length, and folding the last 2mm tip of the rods to a 70-degree bend.



The bent ends of the rod get inserted into the holes vertically. Check and re-check your rod lengths as rods that are too long will cause your pilot to bend upward. Rods that are too short will pull the pilot tip downward. You must aim to keep the pilot base parallel with the rail head.

Note that these braces will prevent the pilot truck from swinging laterally any tighter than a 2.5ft radius curve. If building a 0-6-6T then install the braces per this option regardless of radius! You have no pilot wheel problem to deal with!

Using 5min epoxy, fix the lower end of the rods into the pilot, but do not glue the rod upper end into the BBT chassis yet. Simply let the rods sit in the holes. The cylinder/pilot assembly will remain removable until later in the project.

### **Pilot Braces for 2-6-6T locos Running on 2ft Curves**

If you intend running your loco on curves tighter than 2.5ft radius, i.e. down to a 2ft radius, then you will only be installing one brace. This single brace will be a 1.5mm diameter brass rod, running from the centre hole on the front of the BBT chassis, down to the hole at the tip of the pilot base. Ignore the other two holes in the BBT frame, or the two holes on the diagonals of the pilot base. Glue the lower end of the rod into the pilot base, but do not yet glue the upper end into the BBT chassis. This whole pilot assembly will remain removable at this point.

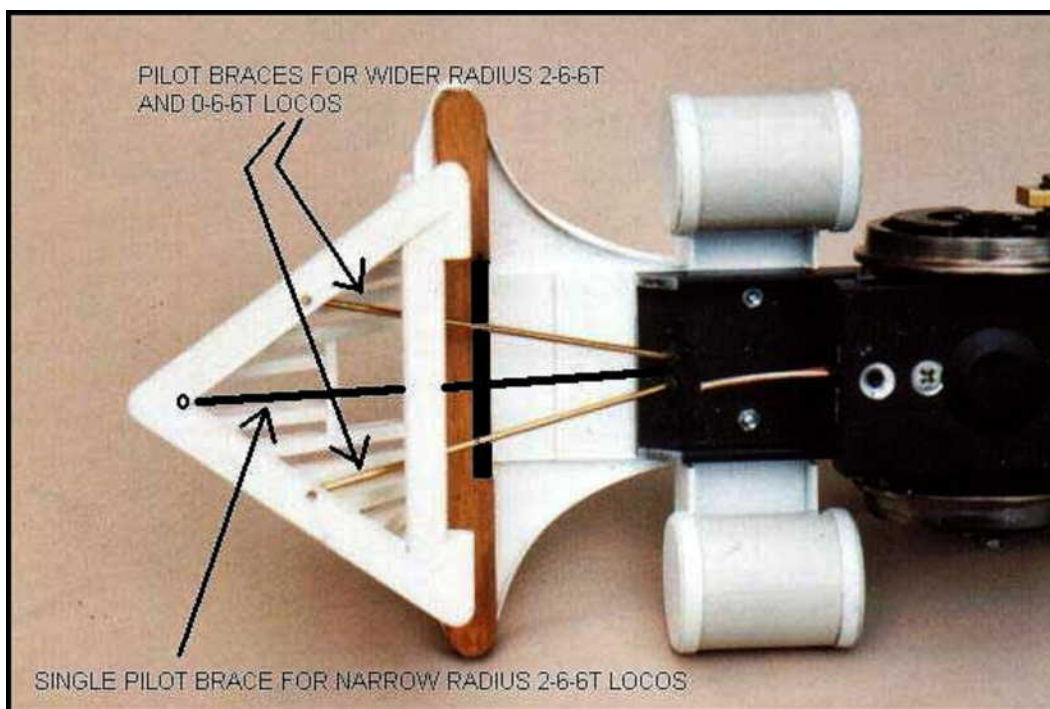

*The above photo shows the prototypical pilot braces installed, as demonstrated with the brass rods. These braces shall only be used on 0-6-6T locos, or 2-6-6T that will run on 2.5ft radius curves or greater. The pilot wheel is shown removed for this photo. However, I would advise installing the braces without removing the pilot truck if possible.*

*The black drawn line in the above photo demonstrates the single brace required for 2-6-6T locos destined for sharp radius curves.*

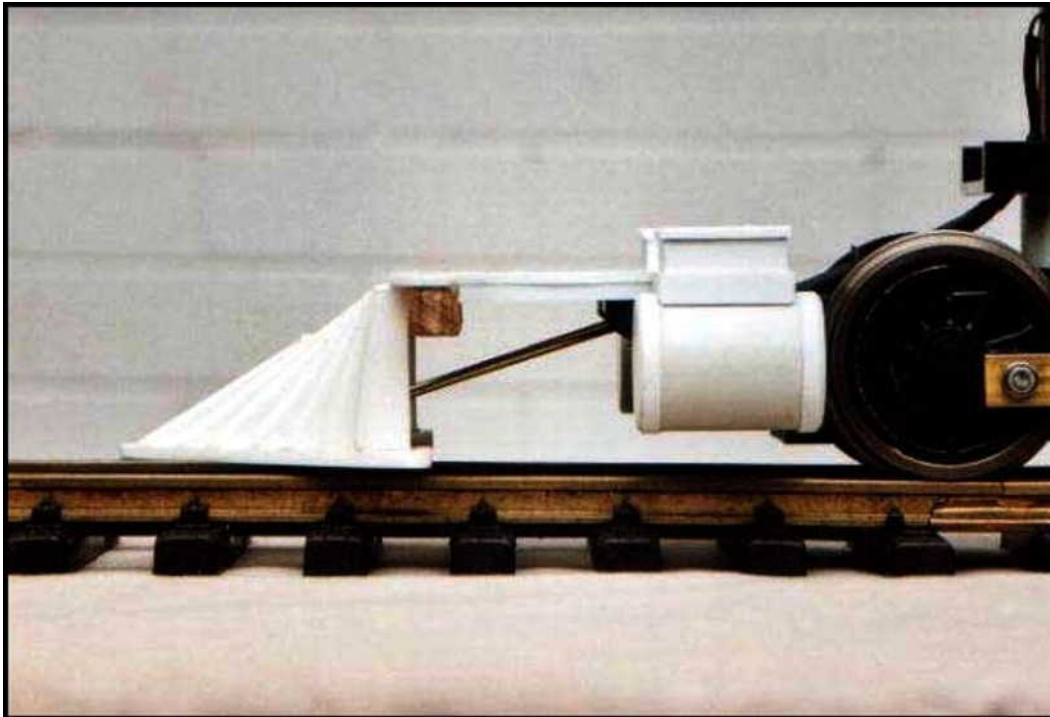

*A side view of the pilot braces. Something like this will be visible on the 0-6-6T type locos.*

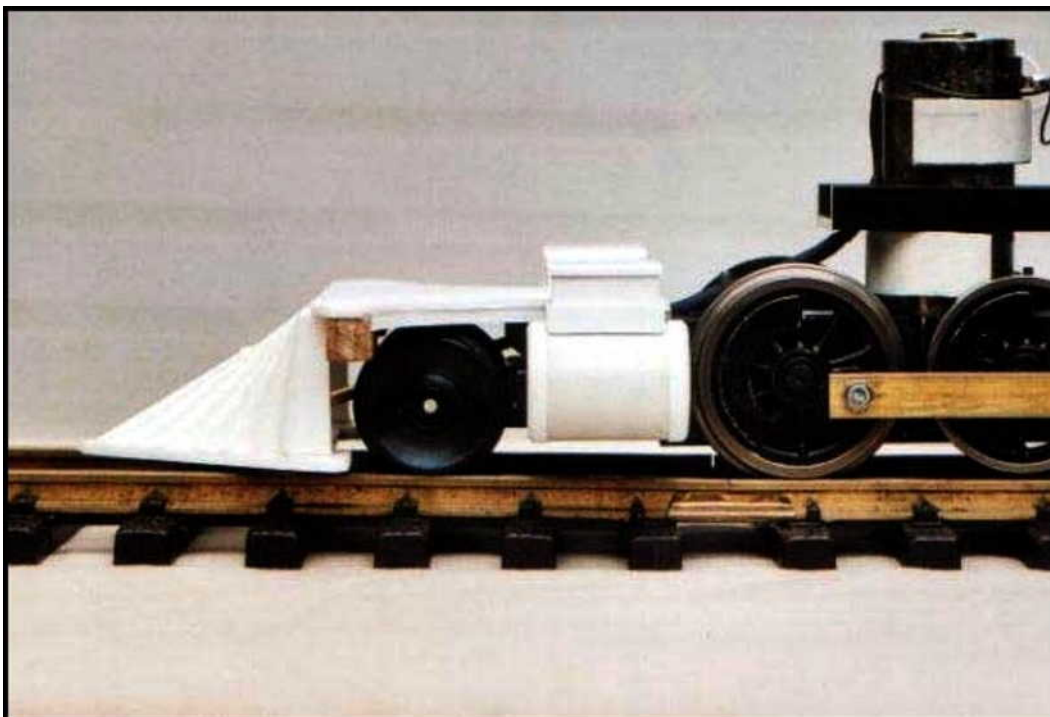

*The above photo shows the pilot braces with the pilot truck installed.*

## Detailing the Pilot

It is now time to add the coupler pole, coupler pocket and rock guards to your pilot. If you want a working knuckle coupler on the front, you will need to look into fixing the coupler back to/under the timber draw bar. Be aware that the South Park Masons were never fitted with knuckle couplers at all during their time on the South Park. Before knuckle type couplers were used, link and pin couplers were the norm. On the pilot, the link and pin is unusual in design, and forms a visible part of the pilot's appearance. The 'link' on the pilot was a long pole that ran down the very ridge of the pilot, becoming one of the visible pilot spokes. Even if you intend to run your loco with a commercial knuckle coupler on the rear, such as a Bachmann etc., you should build the link and pin coupler on the front for decoration or the pilot will simply not look right.

There is a gap provided in the centre of the upper pilot beam. In this slot you will insert the locomotive's forward coupler, either in the form of a link and pin type coupler, or a knuckle type.

- The selection of the actual coupler to use on the front is up to you. The Options are:  
Apply an Ozark type coupler pocket casting, and then make your own link pole. If you intend to have a working link and pin coupler on the front, that will be used to pull a load. I would recommend this metal casting, link and pin coupler. Be aware that the you will probably not be able to find a coupler pocket of exact Mason style.
- Scratch make your own coupler pocket in brass or styrene (we'll demo in styrene). This is decorative only and cannot take loads. The positive of making your own is that you'll be making the pocket to match the Mason design. You'll also make your own link pole.
- Fix a dummy or working knuckle coupler to the draw beam. I'll leave that installation to you, as you will need to investigate mounting heights etc., particular to your railroad.

### Step 1 - Scratch making the coupler pocket

Refer to the Cad templates, entitled:

"Coupler Pocket & Link Pole"

Trace the coupler pocket faceplate template onto 2mm thick styrene. Cut out the center square, maintain the corners as rounded. Using a small file, grind the cut edges of the centre square such that they taper on a 45-degree angle. Carefully sand the coupler faceplate such that the 2mm thickness becomes curved in profile...a curved front face. To cut the centre square out of the plate, you might like to drill the corners first with a 1.5mm drill bit, and then cut between the holes with a knife.

Take your Plastruct 9.6mm x 9.6mm Square Hollow Section (SHS), and cut a 5mm length. Weld the faceplate onto the end of the 5mm SHS. You now have a pretty good coupler pocket. Weld the pocket into the 10mm slot in your pilot top beam. Centre the pocket about the beam. It should appear to step higher than the beam, but lower than the pilot deck top.

Drill a 1mm hole through the top centre of the SHS. Drill through to the bottom of the SHS. Insert a 1/2" long brass 10BA or 1-72 type bolt. This bolt will be the 'pin' in the link and pin type coupler pocket.

The coupler pocket will look like this:

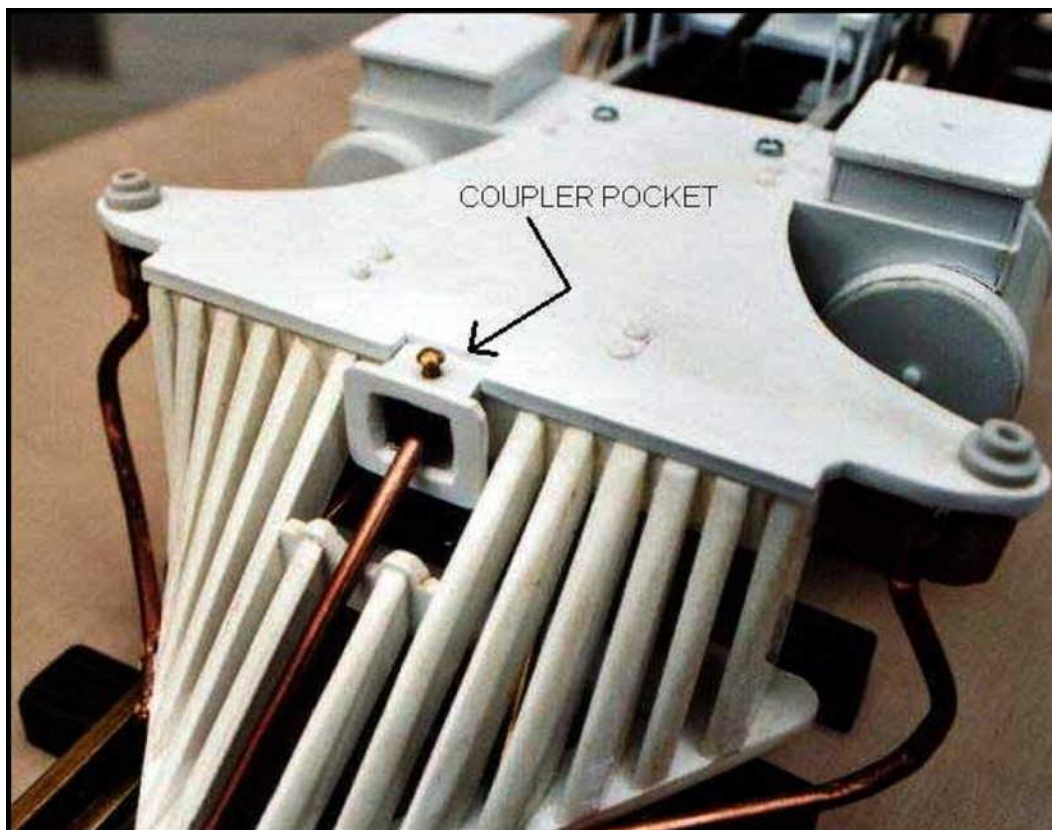

The above image shows the link pole already inserted for context, don't worry, you make that next! Note also how the pilot deck shape now matches the profile you're making. This is evolution CADing at its finest!

## Step 2 - Making the Link Pole

Take your 2mm diameter copper tube. Cut a 55mm length of the tube. Have a good look at your collection of long nose pliers. You will notice there is a grip pattern cast into the jaws of the pliers. Back near the cutting part of the pliers, you will notice the 'grip' stops, leaving bare metal in the jaws. I want you to squash the ends of your copper tube by clamping the pliers around the copper tube, using only the 'flat' or bare part of the pliers. To clamp using the patterned part of the jaws will result in unsightly lines being pressed into the copper.

You need to flatten one end of the tube to a distance of 4mm--this will become the top end of the link pole. Flatten the other end to a distance of 8mm, this becomes the bottom end of the pole. Make sure the flattened ends are aligned with each other. Next using your 1mm drill, carefully drill out the centre of the flattened ends. At the bottom end using small files, carefully widen the hole a little. Using your long nose pliers, carefully prise the hole open, this will bend the flattened section outward a little, making it look wider than the pole itself. Lastly, insert the top end of the pole into the coupler pocket and drop a brass 10BA or 0-80 bolt through the hole in your pole. The coupler pole should rest snug in the 'cradle' formed in the pilot's Transverse brace.



Here we are, a darn stylish 1870s coupler pocket and link pole!

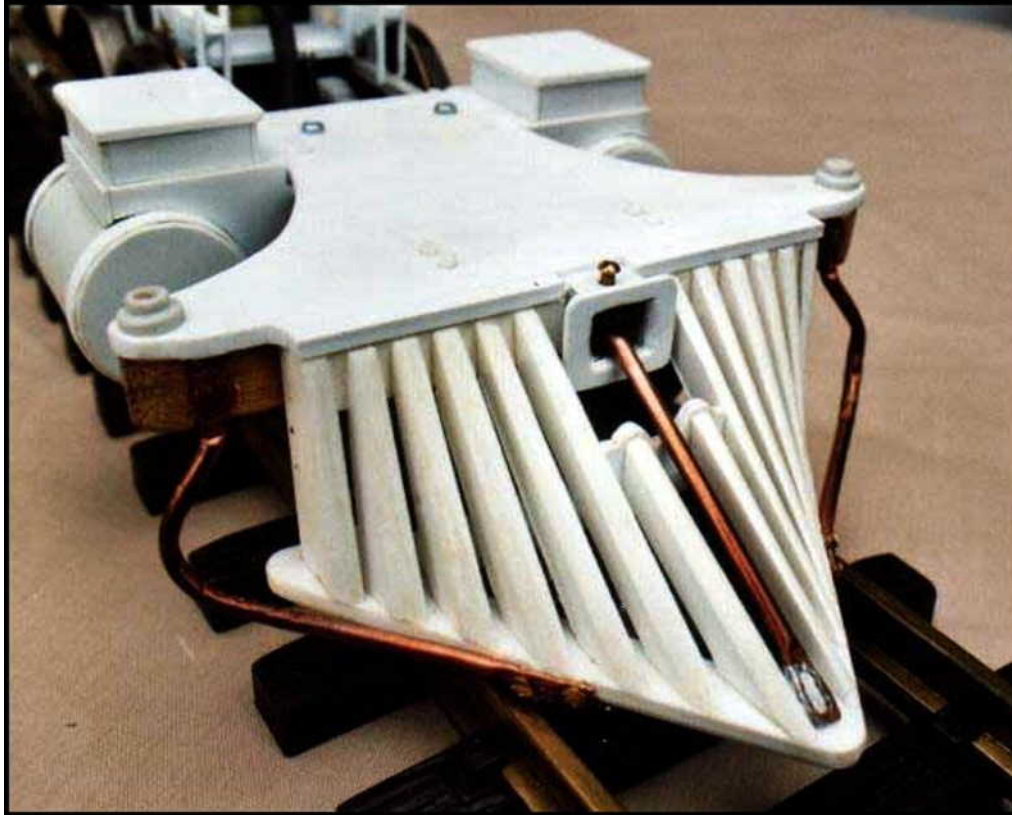

*The cool looking copper rails to the pilot sides are called 'Rock Guards'... and you make them next! Also note the gray styrene 'Flag staff holders' at the tips of the pilot deck - they will be made shortly.*

## **Making the Rock Guards**

Refer to the CAD drawing entitled:  
"Rock Guard Views".

The rock guards were external bars of metal, fixed to the pilot sides that were designed to kick rocks away from the right of way. Narrow gauge locomotives had notoriously low slung cylinders compare to their Standard Gauge counterparts. It was common for these low-slung cylinders to be damaged by rocks at the line side. Even today should you ride the Cumbres & Toltec railroad, or the Durango & Silverton, take note how the cylinder head covers are always dinged by line side debris! The problem was that the pilot was designed to knock debris off the rails, but did not extend laterally enough to protect the cylinders. The South Park's answer to this problem was to install rock guards.

Be aware that the Rock Guards appear to be a design feature unique to the South Park. If you are building a non South Park Mason, you should not be adding rock guards at all! Thus Bully Boy does not have Rock Guards, nor any other non South Park loco. In addition, the rock guards were added by the South Park in their own shops. The as-built photo of DSP&P #4 'San Juan' clearly shows that the rock guards were not added in the factory. A year later however, by late 1879, we can see in the builder's photo of Breckenridge that the rock guards were being fitted at the Mason works. You should also know that over the years the various South Park Masons were seen to have lost their rock guards on occasion.

The outcome of all this is that you do not have to add the rock guards if you don't want to. Masons of the South Park had them fitted, but they didn't carry them all of the time. If building a non South Park loco, you don't need to even think about the rock guards, but hell, if you like the look of them, I'm not going to stop you adding them to your loco!

## Step 1 - Forming the Rock Guards

There is no question this is going to take patience and practice. The rock guard rails are a very 3D form, and I cannot give you a template to follow, other than to demonstrate how they look from the front, side and top. My best advice is to take a 75mm length of solder, and bend it while holding it in place against your pilot. Keep bending it till it looks like the elevations in all 3 dimensions. When satisfied that the solder rock guard looks OK, look after it and don't bend it accidentally. Take your 2mm diameter copper tube once more, and using your pliers, start bending the tube to match the profile of your solder rock guard. When satisfied, using the smooth section inside the plier's jaws, flatten both ends of the copper tube. The upper end will be flattened to a length to match the timber pilot beam depth (9mm). The lower end of the rock guard will be flattened to a distance of 10mm. Using the 1mm drill, drill a hole in the centre of the upper flattened end, and two holes in the lower flattened end. Now comes the real hard part: you will need to copy this first rock guard exactly, and copy it as a mirror image! Make the 2nd rock guard, do it now...no don't get a soda...do it now, or you will not be able to match it!

## Step 2 - Attaching the Rock Guards to the pilot

With the rock guards bent into shape, and holes drilled at the ends. Glue your rock guards into place, using 5 min. epoxy. You may want to use sticky tape to hold them in place till the glue dries. When the glue has hardened, and the rock guards are attached to your model. Drill through the open holes at the ends of the rock guards using the 1.0mm drill. Drill into the pilot beam, and also drill into the pilot base. Next screw tiny brass bolts into the holes, 10BA, 1-72 or even smaller. Your rock guards are not only glued in place, they will also be bolted, and capable of knocking real pebbles away from your line! The bolts are also located prototypically.



## Making the Flag Staff Holders on the Pilot Deck

At the tips of the pilot deck are two flag staff holders. The original Mason builder's photos show the locomotives were initially delivered without these brass holders. In service photos show the flag staff holders added over the years. Also the Builder's photo of Breckenridge shows the holders added at the factory in 1879. The bottom line is that some of the Masons have the flag staff holders, other do not. If you wish to leave out this step, you can leave the pilot deck clean as Mason originally intended. If you want the flagstaff holders, they are simple to make.

If going with the flagstaff holders, this is an ideal time to insert bolts through the pilot deck down into the timber draw bar for the ultimate screw fix. Drill and screw in 6mm long brass 8BA or 0-80 bolts, drill them dead centre of the flag staff locations as shown on the CAD templates. We'll conceal the bolt heads under our flagstaff holders.

The flag staff holders are made from two layers of 2mm styrene. The lower layer is 7mm in diameter. The upper layer is 4mm in diameter. Weld one on top of the other. When hardened, drill out the centre with a 2mm drill bit. Weld the staff holders to the pilot deck, such the edge of the circular staff holder is parallel with the curved edge of the deck plate.

A tip in cutting circles out of styrene. Cut a square first, then lop of the corners off forming an octagon, then lop off the corners again creating a 16 sided shape, then sand the edges ... BAM, one styrene circle!

## **Making the Cylinder Drain Cocks**

A detail often left off commercial models are the drain cocks at the bottom of the cylinders. The cylinder drain cocks are used to drain water out of the cylinders when a steam loco starts into motion. The cocks are also opened when the crew wish to back off on the amount of steam being vented to the stack.

The drain cocks are simple to make. There are essentially two small cocks to be installed at each end of the cylinder base, with a horizontal control rod between them. The cocks are to be made from 3mm diameter styrene tube. Drill a 3mm hole at each end of the cylinders, along a base centre line.

Cut four 10mm lengths of 3mm diameter styrene tube. 2mm inboard from the end of each length drill a 1.5mm hole. Insert the four tubes into the cylinders, such that only 5mm of the tube is projecting. Next run a 27mm long 1.5mm brass rod between these cocks, by inserting the rod into the 1.5mm holes near the ends of the cocks. Fix in place with welder cement. The drain cocks will be painted brass when you paint the model in the next chapter.



*The cylinder drain cocks shown installed at the base line of both cylinders.*



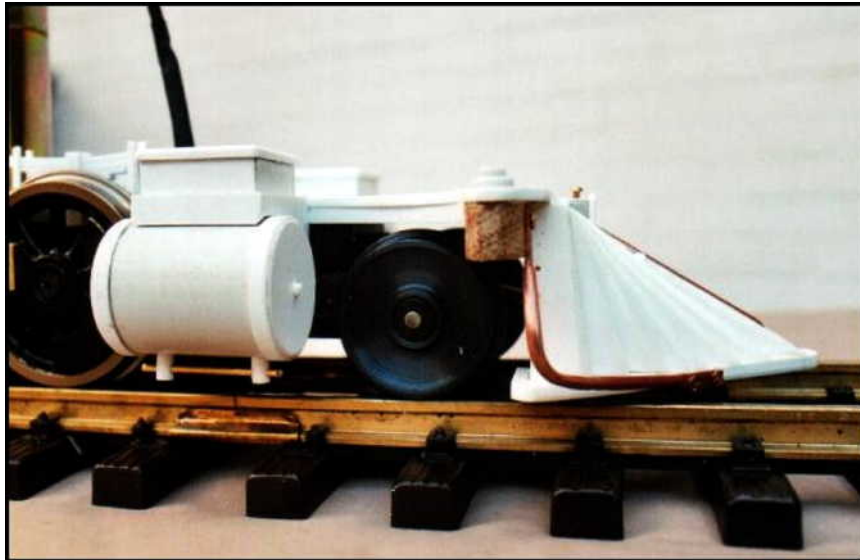

## The Chassis Springs and Pivot Support

You will have noticed that the vertical Pittman motor in the BBT chassis forms the pivot for the Mason articulated frame. This system provides for a robust and reliable pivot that is dead simple in its construction. You will also notice therefore that the pivot is just forward of the chassis centre line. The prototypical pivot point was directly centered above the middle driver. Barry at BBT and I worked pretty hard to develop the optimum pivot location for the model and agreed on the pivot in the forward position for reasons that will become obvious when you build the Mason valve gear. The motor pivot is exactly in line with the valve gear 'lifting rods', and thus it will be possible to keep all the valve gear components connected prototypically, even when the loco runs over un-prototypically tight curves!

## Deciding on the Pivot Support

The pivot support is the pad that the main Mason Bogie frame rests upon. On the BBT drive, you will notice that the main Mason frame is resting atop a PVC pipe type clip, clamped around the lower motor area. A second clip of this nature is clamped around the top of the motor, preventing the chassis from dropping out of the Main Mason frame.

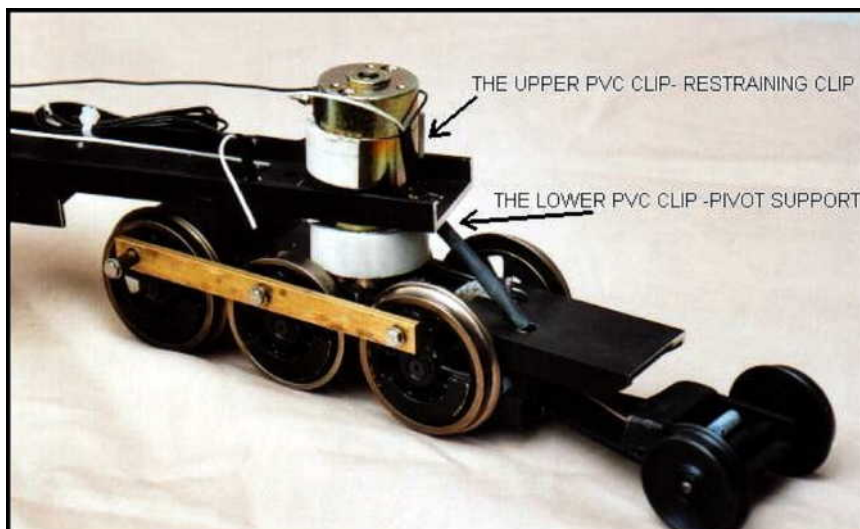



The height of the lower PVC clip sets up the height of the whole Mason above the drivers. Barry has cut this PVC clip to the correct height for you.

For ultimate robustness, I would advise leaving this clip just as Barry has installed it. This clip provides support for the Mason superstructure, over all rail curve radiuses. The down side of this clip design is that you cannot install the chassis springs above the middle driver, due to the thickness of the PVC clip. You will however be installing the chassis springs to the lead and last drivers, and ultimately painting the springs and PVC clip black. For those that want a robust, totally reliable model with a reliable pivot, then the loss of the centre spring detail in the darkness should not be a concern.

For those that want the full prototypical detailing, including the spring rigging to all 6 drivers, then this PVC clip has to be removed, and a smaller 'pad' like support will be constructed just behind the motor. This pad will enable the chassis detailing to be more accurate, and the pivot support pad will support the superstructure extremely well over trackage with reasonably sharp curves. Be warned however that as the chassis pivots, the pad behind the motor will slide further away from the loco's centerline and center of gravity. Thus it is possible, on extremely tight curves, for the superstructure to 'wobble' because the support pad is effectively off to the side of the loco's centre. In testing, this problem only arose on curves even tighter than 2ft radius.

I leave the choice of pivot pad to you. Leave the PVC clip as is, or make the new pad! We'll demonstrate how to build the full spring details and the new pad.

Time to Drop the Pivoting Chassis out from the Main Frame:

In order to make the spring details and, in a coming chapter, build the valve gear, it is necessary to drop the chassis out of the frame, so you can work on the unit as a small 2-6-0!

First you must unsolder the wires leading up to the motor. Using a soldering iron, carefully pull the wires free of the motor tabs. Do not over heat the motor terminals, or you can damage the motor. If unsure please ask in the [MasterClass forum](#), and Barry, myself or others can advise.

Next you need to remove the upper PVC clip. Basically push/slide it away from the motor and store in a safe place. You will need to put it back on later.

Rotate the entire 2-6-0 chassis around 180 degrees, such that the pilot is now facing rearward. Push the motor and chassis downward, guide the motor through the hole in the frame. You should now have a tight 2-6-0 chassis, and a separate Mason main frame, with tender truck on rear. Do not re-attach the wires to the motor.

## **Making the Chassis Springs**

Refer to the Cad drawing entitled:

"Chassis Springs and Pivot Pad"

The chassis springs are our representation of the leaf 'rocker' springs used on the Mason bogie as part of the Mason equalized suspension system. These will be styrene 'dummy' springs as the BBT chassis is already equalized as part of its internal design.

The springs can be made using 1mm thick styrene, cut into 3mm wide strips. Go ahead and cut a few 200mm long strips of styrene. You will make 6 springs in all (if removing the PVC clip, otherwise only 4 springs).

## Step 1 - Making the Spring Units

Decide if you will be retaining the lower PVC clip, and only making 4 chassis springs. If you're going to do the full story, and make all 6 springs, then its time to remove the lower clip, press and slide it away from the motor.

On the Spring template you'll see the profile of each leaf of the spring shown. You'll also see the spring supports shown for both sides of the assembled spring.

Each spring is made from 7 layers of the 3mm wide styrene strips, forming a triangle. When you have successfully weld laminated the 7 layers together, carefully bend the triangular form such that the top layer displays a subtle curve along the top. To both sides of the triangle you weld another strip of 3mm wide styrene. Weld a 3mm x3mm capping piece on top between the side strips. These simulate the shackles that run down to the wheel journals. At the ends of the springs, you will install 1mm x 1.5mm strips of styrene, forming the spring 'hangers'. Each spring will be fitted with 4 hangers, but the centre spring will only have 3. The 4th hanger rod on the middle spring would otherwise clash with the motor side. To be really precise the tops of the hangers should have an oval hole drilled in, and a tiny wedge inserted, that should span between the hangers on either side of the spring ... tiny details indeed, but I'll leave that to you!

Here is a photo of the real Mason Bogie Spring detail, note the holes, and wedge at the tops of the hanger rods.

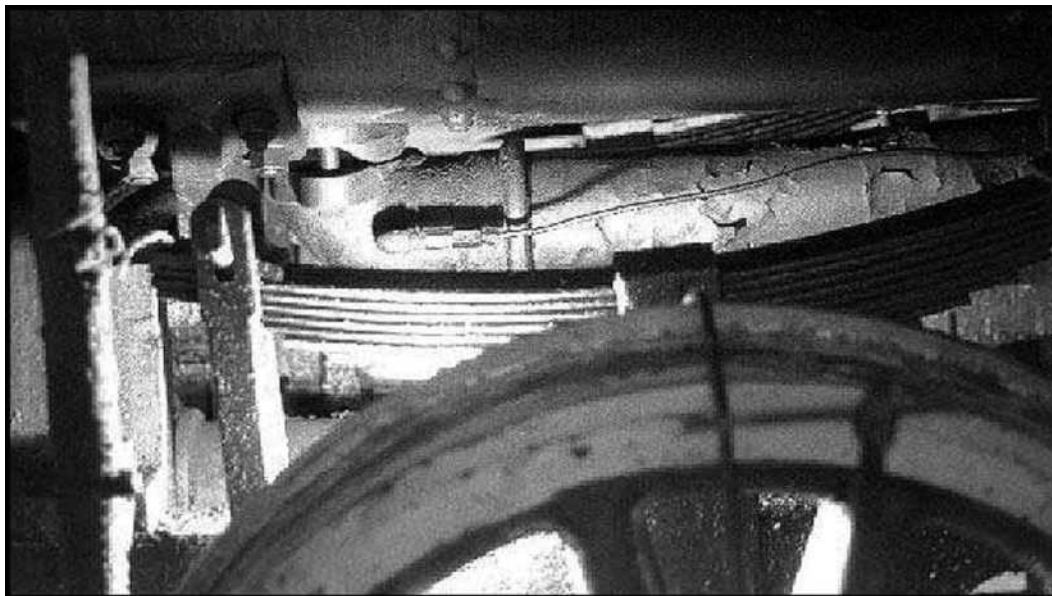

*Detail Photo, Spring rig of the 1873 Mason Bogie "Torch Lake".  
Photo courtesy of George Sebastian Coleman.*

## Step 2 - Making the Spring Frames

OK here is where we use a material not originally listed in the Chapter 1 parts list. We make a frame to hold the springs. The frame sections can be made using Plastruct 3mmx3mm SHS ABS rod, or you can simply make up your own 3mmx3mm rods using 2mm and 1mm styrene laminated together. The quantity required is very small. You can decide whether you'll make your own 3mmx3mm rod or buy it.

Attach each spring unit to a Plastruct (or similar) 3mm SHS base rod. The rod as shown in the PDF drawing shall be 148mm long, designed to run the entire length of the chassis from behind the cylinders. You will need two base rods, one for each side of the chassis, to support 3 springs each. Test the fit of the base rods on the chassis first. Note that you will need to file away the side of the SHS where it passes the motor (see template for cut sides around motor). The side of the SHS in place must be absolutely flush with the chassis sides. Do not glue the base rods in place yet. If retaining the PVC lower clip as the pivot support, your base rod will be cut into two sections, butting up to the PVC clip.

When satisfied with the base rod's fitting, then weld the styrene spring assemblies to the base rods. They should clamp over the sides of the base rods. Check that each spring is directly centered above each wheel when attaching to the base rod. A typical base rod with springs attached should look like this:

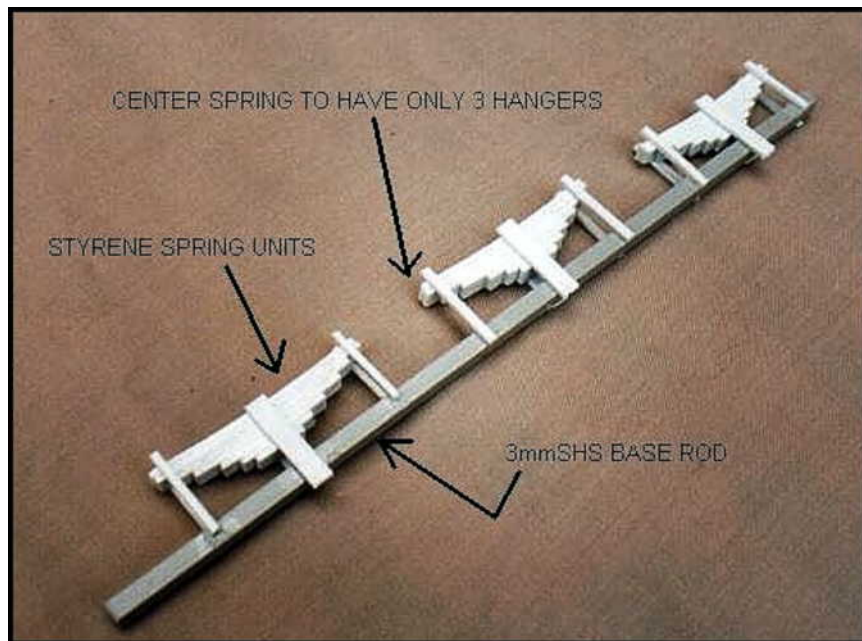

With the rod and spring unit resting in place (not glued!), the chassis will look like this:

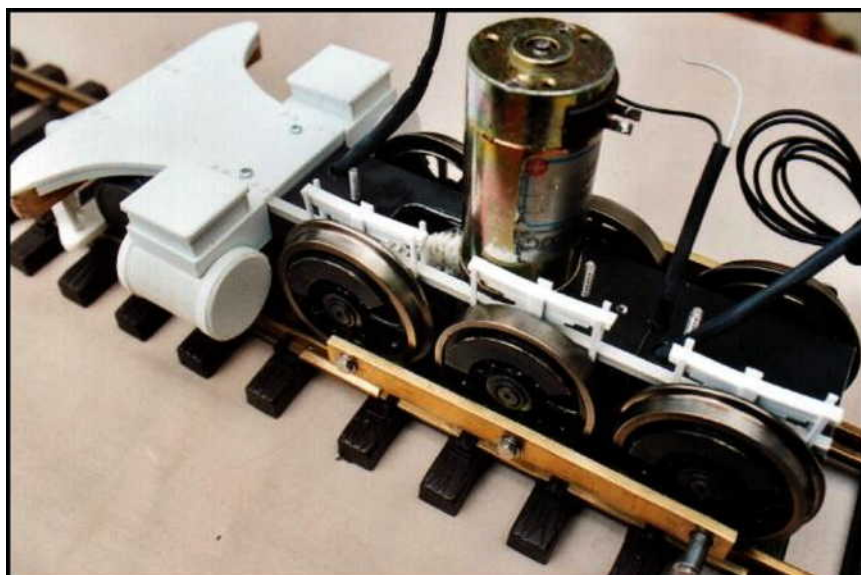

Note if you are going to retain the PVC lower clip (shown removed in the above photo), your base rod will in fact be in two parts with a section and spring forward of the motor and a second rod and spring to the rear of the motor, trim the base rods so that they fit snug up against the PVC clip.

Repeat the spring and base rod assembly for the other side of the loco.

### Step 3 - Valve Gear Base Plate

With both base rods and springs located in position on the chassis (not glued). It is time to connect the two rods together, and form a base plate between them for the purposes of mounting the valve gear mechanism later in the series. The base plate is to be a rectangle of 2mm thick styrene, 18mm long, x 35mm wide (or the width of the chassis). Weld this plate directly to the top of the 3mm SHS base rods, such that one side butts into the motor, and the other is near the central mount of the lead springs. This must be a solid weld. The future of your valve gear depends on this!

The finished spring and base plate will look like this:

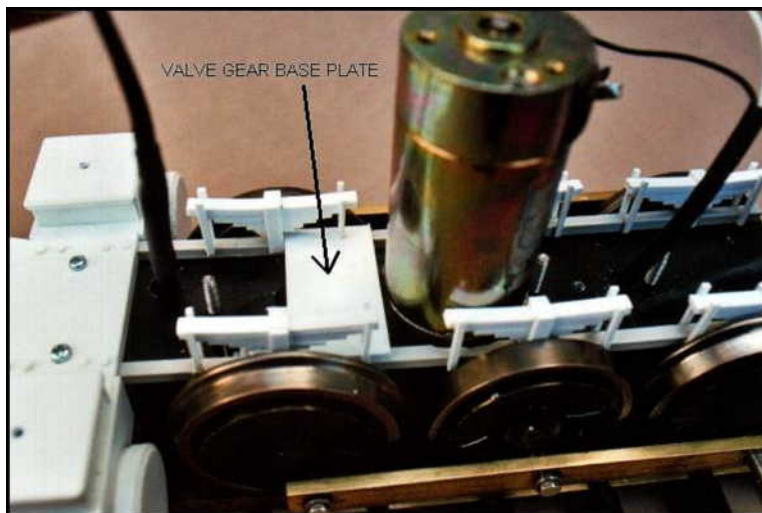

*Note in the above image that one of the spring hangers has to be cut short on the lead springs, in order to let the base plate run atop the base rods.*

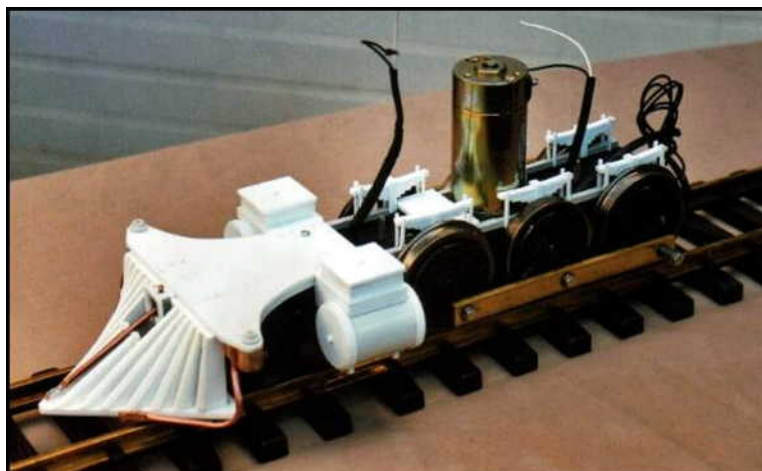

The story so far.....



## **Making the Pivot Support Pad**

This step can be ignored by all those retaining the lower PVC clip as a pivot support.

We will be making a simple pivot support pad made up of Plastruct ABS SHS rod, with a 2mm styrene glide plate on top to support the Mason main frame above. The pad will be made to fit between the chassis springs, directly behind the motor.

### **Step 1 - Making the Support structure**

The support structure is made up of two sections of 9.6mm x 9.6mm Plastruct SHS rod. Cut two lengths of this rod, 22mm long. Stack the two 22mm lengths one atop the other on their sides, and weld together. Next cap the open ends of this structure with rectangles of 1mm thick styrene, 9.6mm wide x 19.2mm tall...refer the springs template.

### **Step 2 - Mounting the Pad structure**

Look at the BBT chassis top behind the motor. At a distance of about 15mm behind the motor you will see a bolt head sticking out of the chassis top. Unscrew the bolt, and you will find an unused hole. The bolt is approx. 1/2" long and will be used for the pad. This hole has been provided courtesy of BBT; it is even tapped for our convenience (has a bolt thread formed in the sides of the hole). This tapped hole is for the purpose of mounting our Pivot Support Pad. Measure the diameter of the bolt, and also measure the diameter of the bolt's head.

Here's the deal, you need to drill a hole right through the your styrene pad equal to the bolt's thread size. Drill down from the top centre of the pad unit. Next change the drill size over to one that is larger than the bolt's head size. Drill into the central hole of the pad again, but this time, only drill through the upper most layer of styrene and stop.

Drop the pad unit onto the chassis top over the bolt hole. Take the BBT bolt, and drop it into your pad unit. It should drop into the innards of the pad unit, with the head falling into the upper Plastruct SHS. Use a couple of daubs of Super Glue on the base of the pad between the chassis top and underside of the pad. Tighten the bolt such that the pad is now firmly bolted down to the chassis. The head of the bolt will be resting against the inside of the upper SHS unit. See template for sectional view of the pad.

### **Step 3 - The Glide Plate**

When the pad is tightened down, and can't move you now cover the top of the pad unit with a shear plate or a glide plate, that supports the Mason's main frame yet allows the frame to glide across the plate with little resistance. The glide plate is made from a rectangle of 2mm thick styrene 15mm x 35mm. Weld the plate down atop the pad structure, pushing the plate toward one side of the pad, such that the plate almost reaches over and touches the rear side of the motor. By doing this you will cover the access to the bolt forever, and in doing so provide a strong, yet smooth topped pivot support structure.

The finished pivot support structure will look like this:

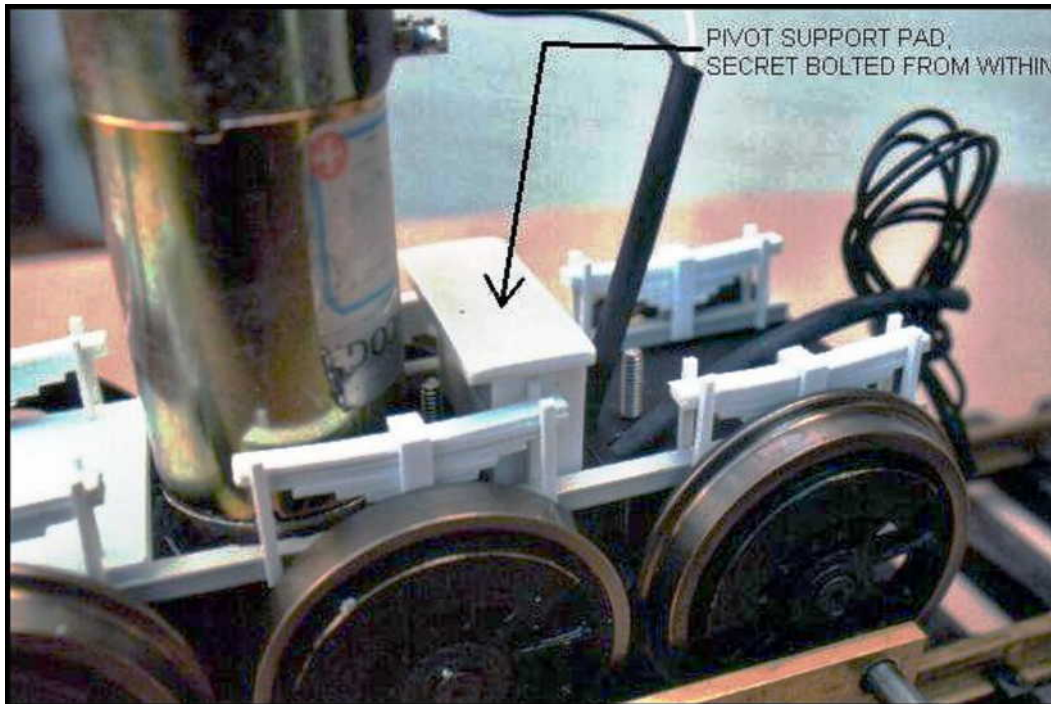

*With the Mason Main frame attached, the frame member will slide across the pad top. The next photo shows the glide plate below the Mason frame on what would be a ridiculously tight curve!*

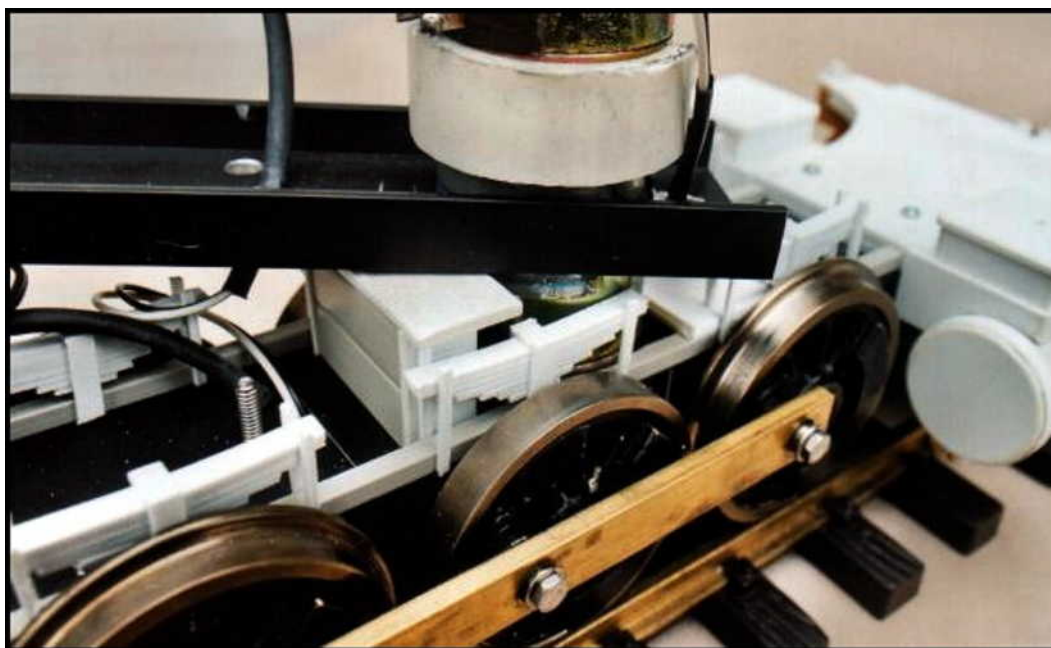

## Making the Cab & Tender Deck

Chaps, we're nearly at the end of this chapter! The Cab and tender deck is easy to make in comparison to the stuff you've just achieved!

You're down to one last remaining CAD template sheet, entitled "Cab and Tender Deck Profiles".

### Step 1 - The Deck Plate

Note that the actual tender deck profile is drawn at half required size (the deck drawing would simply not fit on the page!).

**Huge Caution and Warning** - The length of the deck plate varies depending on which Mason Bogie option you are building. Specifically Option 4a and 4b have longer decks. Please make note of which option you are building, and cut your deck plate to the correct length.

Hey its time to show you my cards! Guess what...I'm going to be building Mason Bogie Option 4A as the demo model for this class. That's the post 1883, short tender loco, with Westinghouse brakes and Congdon stack. The loco is an old favorite, DSP&P #42, "Ten Mile", formerly DSP&P #6, of 1879. This version has an extended deck, but not as extended as Option 4B (long tender). Thus you will note that my sub floor framing at the rear is spaced slightly differently to the normal short decks of all other options. Stick to the drawings and you'll be OK.

While the deck lengths are different between the options, the pivot location of the tender truck is always in the same place relative to the leading edge of the deck. We use this truck's pivot point to accurately locate the tender deck on the locomotive frame.

Measure the deck profile, multiply the length and width measurement by 2, and copy those dimensions onto 2mm thick styrene, cut out the profile. This is your tender deck plate. Using sand paper, carefully sand the edges of the deck such they are rounded or 'bull nosed' in profile.

At the location shown on the template, drill an 8mm hole in the deck for the tender truck bolt to pass. Also trace and cut out the tender deck packer.

### Step 2 - Making the Under-floor Supports

On the real Mason Bogie, below the deck plate are 12 cast iron floor supports or Joists, six to each side of the loco. We'll be making these items from 3 pieces of 1mm thick styrene. Trace and cut out the Floor Joist profiles 12 times, from 1mm thick styrene. Mason Bogies with extended decks, Option 4b only (Long tender with air tank on rear), will need to make 14 joists. The joists are made up of two side plates, and a single square end plate. Near the corners of the square plate weld 4 rivet heads. We make these small rivet heads by dicing our 0.020" x 0.040" Evergreen rod into tiny cubes. Weld the 3 parts of the joist together as shown in the

photo. The two side plates are to be 6mm apart. Repeat this work 12 times or 14 times depending on deck length.

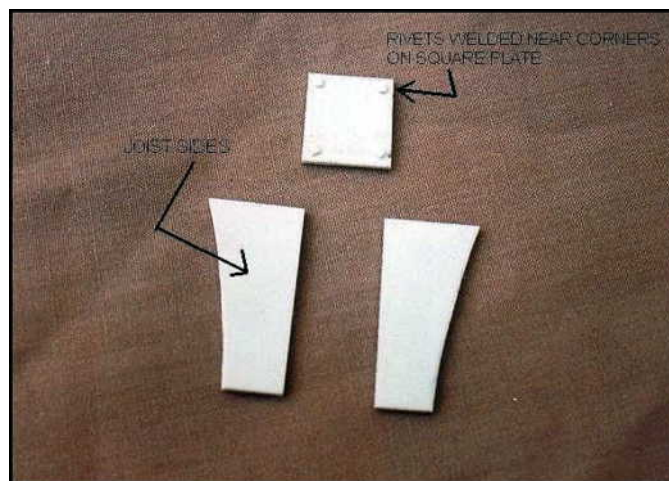

*Image of the 3 parts to a typical joist.*



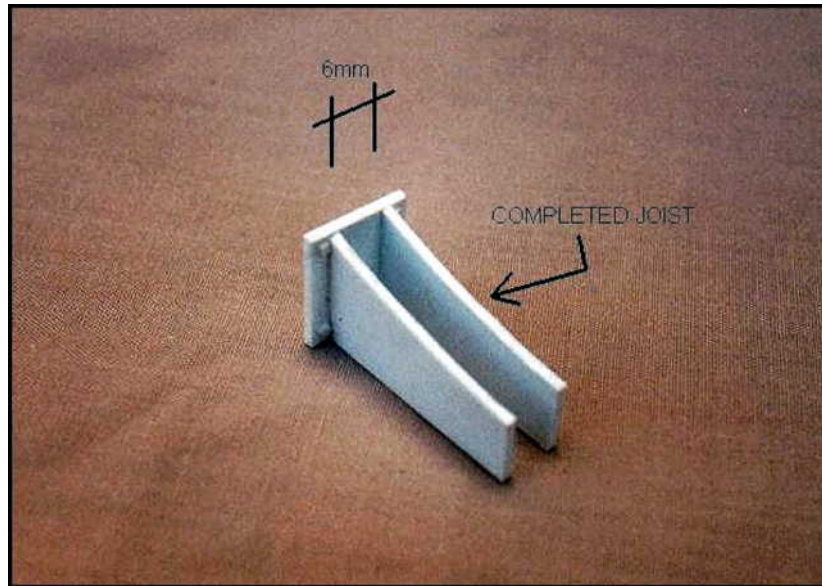

*A completed joist, now repeat this another 11, or 13 times!*

Mark out the joist locations on the deck plate by drawing a series of pencil lines. Follow the deck template to measure out the places to draw the lines. Also locate the centre line of the deck and draw that line onto the deck.

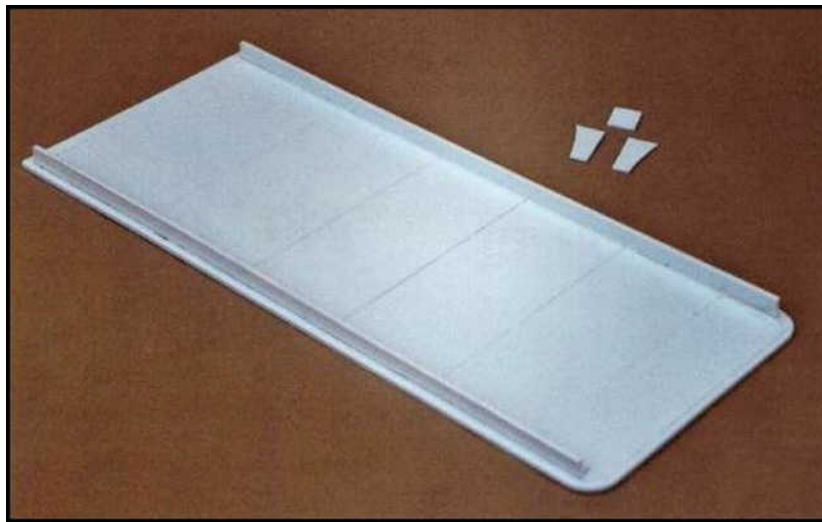

*The pencil lines are evident in this photo, ready to locate the floor joists.*

### **Step 3 - The Tender Deck Fascia**

Take your 2mm thick styrene sheet and cut some 6mm wide lengths. You will need approx. two 300mm lengths, and two 120mm lengths. These 6mm wide strips form the deck fascia. Install a 6mm fascia around the entire perimeter of the deck. Note the cutout at the leading edge of the deck as indicated on the CAD template. Weld the 6mm wide fascia exactly 3mm inside from the deck edge. You will notice the rear end of the deck has curved corners. You can either warm the 6mm fascia and bend it around the curve, or cut the fascia short and install a 6mm tall 90-degree segment of 12mm diameter Evergreen tubing to form the curved corner.

When you have welded the fascia into place, 3mm inboard of the deck perimeter, install all 14 of the joist assemblies. Align the centers of the joists over the pencil lines.



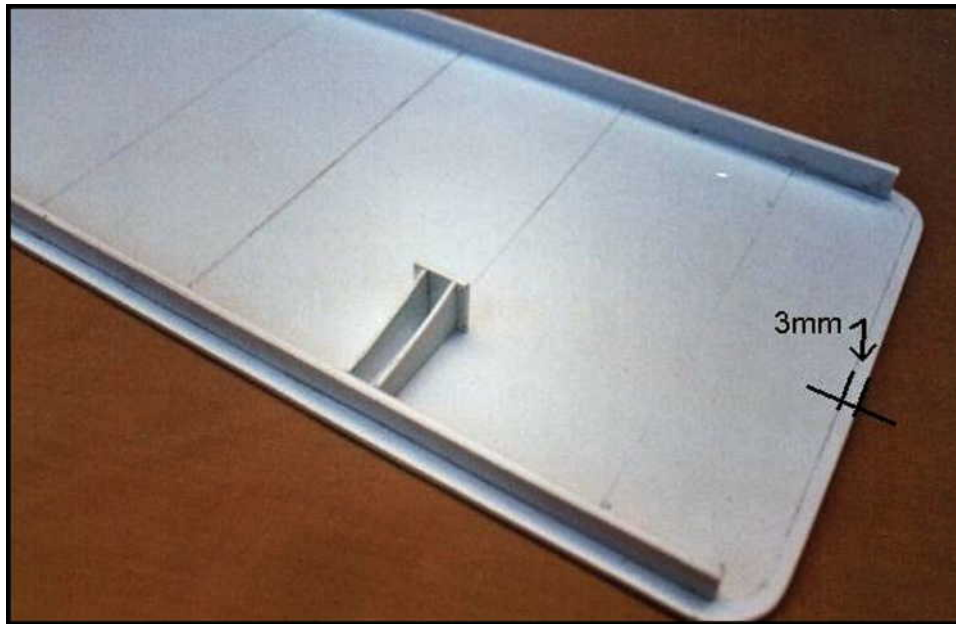
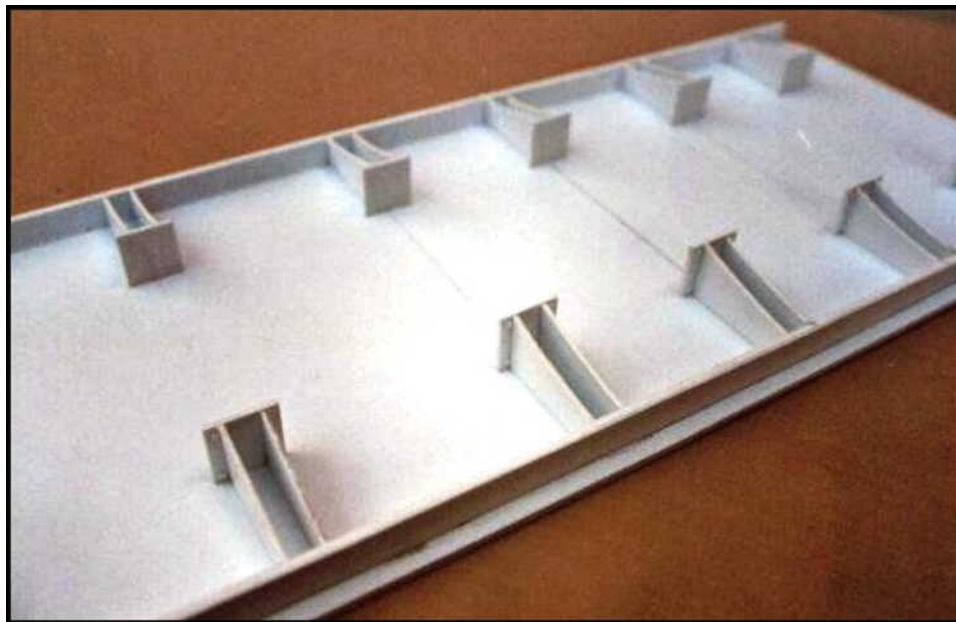

Image showing the 6mm tall side fascias installed and a single joist aligned over the pencil lines. Note that the joists are not all evenly spaced!



*All 14 floor joists welded into place.*

#### **Step 4 - The Deck Inner Framing**

Take your 2mm styrene sheet again, and cut some 12mm wide lengths. You will need two lengths at approximately 300mm long, and one length at 60mm long. These form the deck's inner framing. Using the welder cement, weld these inner frames, hard up against the back plates of the joist members. These frames will run the entire deck length and butt into the fascia at the front and back of the deck. Finally between the two inner frame lengths at the rear, close up the gap between the frames with the 3rd 12mm wide strip. Trim the strip to fit and weld it flat directly behind the rear fascia.

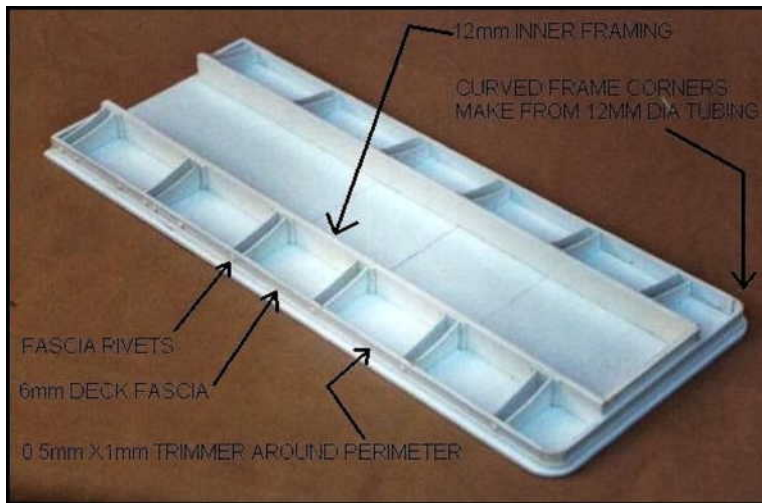

The image above illustrates the 13mm tall inner framing, and 13mm tall plate to the rear deck.  
The image also shows the deck detailing about to be done.

## Step 5 - The Deck Detailing

We need to add a 'molding' at the interface of deck and fascia. Take your 0.5mm thick styrene sheet, and cut some 1mm wide strips. Run a continuous 1mm tall strip around the entire perimeter of the fascia, at the interface between fascia and deck.

Typical of Mason's style, there are minimal exposed fixings, or bolts to be seen. There are no exposed threads, or washers of any kind. The only fixings that are visible are some bolt heads without washers along the centerline of the fascias, at each joist location. Take your Evergreen 1.5mm diameter rods, and slice some 1mm long cylinders out of the rod. Weld one cylinder (bolt head!) to the side fascias exactly centered on the joist locations.

At this point it is also desirable to add a couple more bolt heads. Looking at your options drawings from chapter 1, you'll see the joist bolt heads in the locomotive drawings. You will also notice a cab step below the deck fascia, directly below the cab door. Weld onto the fascia a couple of bolt heads at the locations where the cab steps will go. We'll be adding the cab steps later in the project. Apply these two bolts to both sides of the loco.

Model builders that want to have a Westinghouse air brake system added to their models might also like to add the two bolt heads seen on the fascia where the 'Surge Tank' will later be located. Air Brakes are fitted to Options 3, 4 and 6. The Surge tank can be seen on the chapter 1 drawings directly under the cab floor where the cab's two arched windows are.

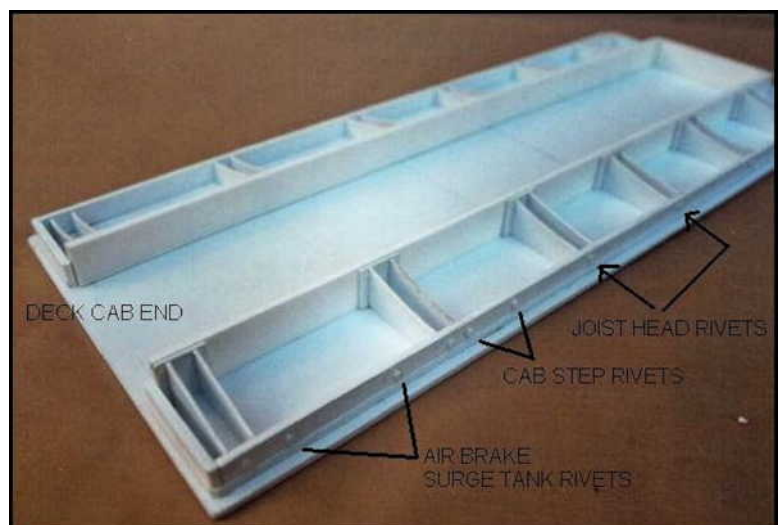

## Step 6 - Installing the Deck to the Chassis

It is now time to unbolt the 4 bolts holding the two frame members of the BBT drive together. These 4 bolts can be seen directly behind the locomotive's 2-6-0 chassis. Undo the bolts and put them in a safe place.

Running along the tender section of the BBT frame are 6 more bolts screwed into the frame top. Unscrew these and store them away. Taking just the BBT tender frame section, with the tender truck still attached, place your styrene deck assembly onto your BBT chassis. Align the hole in the deck over the tender truck bolt head... this will locate the deck correctly onto the BBT frame.

Turn the chassis over so that the tender truck is facing up. Between the 12mm tall styrene inner frame members and the edges of the aluminum BBT frame is a gap. Take two lengths of your 6.4mmx6.4mm Plastruct SHS members, and weld them into the gaps. They will run the length of the chassis. The deck assembly should now fit snugly over the BBT frame. Check your centerline pencil mark and check that it is aligned exactly with the BBT frame centre line. You must ensure your deck is perfectly parallel and centered relative to the BBT frame.

If you don't have your BBT drive as yet, make note the BBT frame members are 35mm wide...make sure you leave a 35mm min clearance down the center of your deck between the framing.

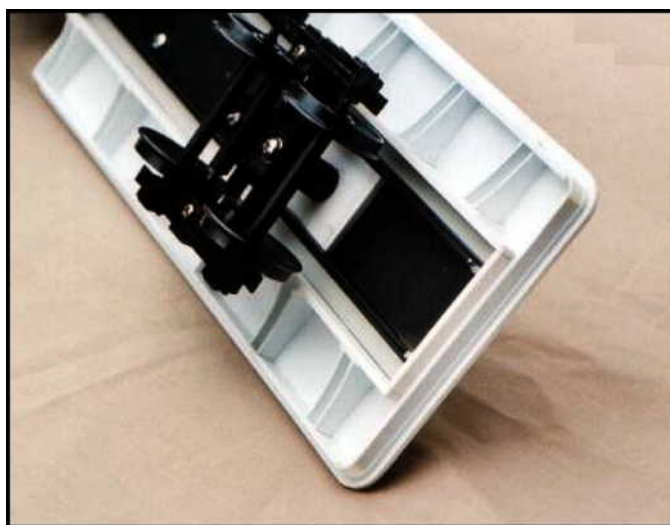

*Image above shows the BBT frame dropped into place, between the two 6.4mm SHS packers.*

Using a pencil, mark out the 4 holes in the BBT chassis from under the deck, using the BBT frame as a template. Mark out the 4 holes at the lead end of the BBT tender frame. Take the deck off the BBT frame and drill 3mm holes into the styrene deck. You will be drilling out 8 holes in all. Place the deck back onto the BBT frame. Screw the 4 bolts into the deck from above, and tighten, then re-check your deck to BBT frame alignment.

Take the 2mm thick deck 'packer' as copied from the CAD drawing, and drill 4 holes into that to correspond with the 4 bolt holes at the lead end of the deck assembly. Weld the plate to the deck top, while keeping the holes aligned. This deck packer is used atop the cab/tender deck at the lead end to pack between the two halves of the BBT Mason frame. The Mason frame is made up of two 'U' shaped channels. The channel above the steam chassis and motor is an upright 'U', the channel that runs under the tender deck is an upside down 'U'. The two channels come together at the front end of the cab floor. The two channels also need to have a 4mm thickness packed between them...that is the 2mm thick cab/tender deck, and the 2mm thick packer =4mm.

Now we bolt the chassis back together. Take the 4 longer bolts and bolt the two halves of the BBT drive back together. There are now two layers of 2mm styrene packed between the two BBT frame members: the 2mm thick deck, and the 2mm thick packer.

In the middle of the interface between the two BBT frame members is a hole for the tender truck wires to run. Using the BBT frames as a template, drill this hole through the 4mm thick styrene as well in preparation for the tender wiring.

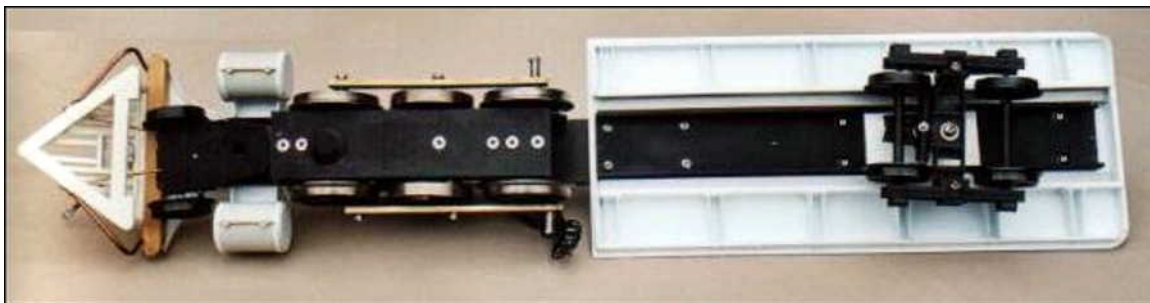

## A Rear Mounted Pilot

The North Pacific Coast Mason Bogies were often run tender first, and there is photographic evidence that demonstrates how these locos carried a pilot or cow catcher on the rear as well as on the front. Those of you building Bully Boy or freelance Masons who would like to mount a cow catcher to the rear draw beam will need to adapt the work shown above. Note that Bully Boy was not delivered with a rear pilot, but it is reasonable to assume that she had a pilot on the rear at different times. If you are building the Bully Boy, you do not have to add the rear pilot because she would have been run with and without the pilot over her lifetime.

### **This step is not relevant to South Park Masons:**

Build the tender deck and sub floor framing as described above. You cannot simply affix the new pilot direct to the rear deck framing as it is considerably higher above the railhead than the front pilot beam is. At the rear, between the curved frame corners, you will need to add an 80mm long, 22mm deep, 6mm thick, laminated vertical plate, made from 3 layers of 2mm styrene. This styrene beam is to be suspended under the deck. Basically, install a 2mm thick 22mm deep plate to the rear of the deck framing, a second plate to the lead side of the rear framing, and an 16mm deep filler plate between them. Support this new-



beam in a vertical position by bracing it against your inner 12mm deep frames using two triangular supports, welded to the sides of the main framing. Detail this new beam using your 1.5mm rivet stick (hit me!): locate 4 rivets as shown in the following photo (these rivets also coincide with where your triangular supports rest behind the beam, as per prototype) Speaking of pilots and cow catchers, if you want a rear mounted cow catcher...go back to the start, and do not collect \$200. "You poor bastards," is all I can say, "to have to scratch make two pilots from the same templates!...ouch!" (If you're using the FH&PB cab and pilot kit, be sure to ask for a second pilot.)

The following photo is of the NPC San Raphael seen from the rear. Note the iron plate fixed to the rear framing to lower the pilot to the correct height. The same type of work is required on your Bully Boy 0-6-6T models if you desire to do this. Weld some 1.5mm diameter rivets onto your beam as shown in this photo.

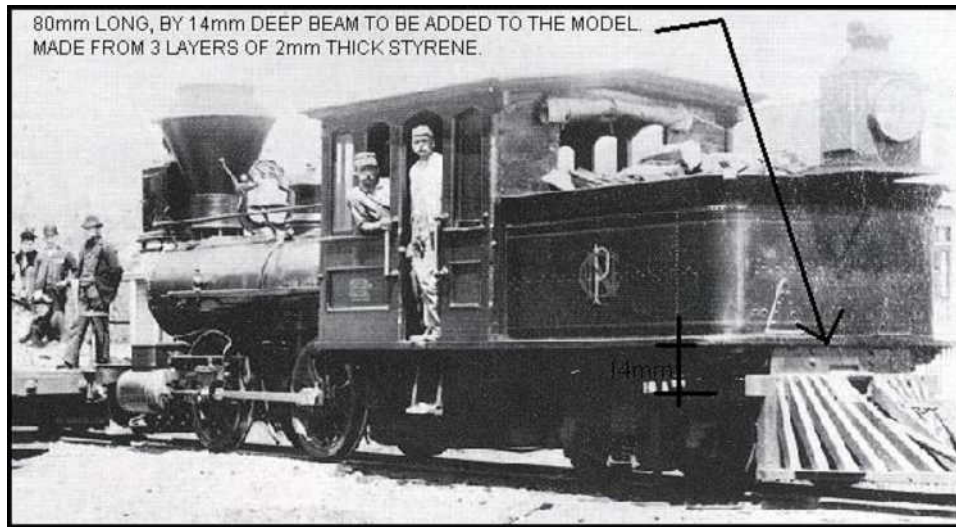

Here is a diagram of the finished pilot added to the rear of the loco, note the 3 layers of 3mm styrene forming a new pilot beam at the rear.

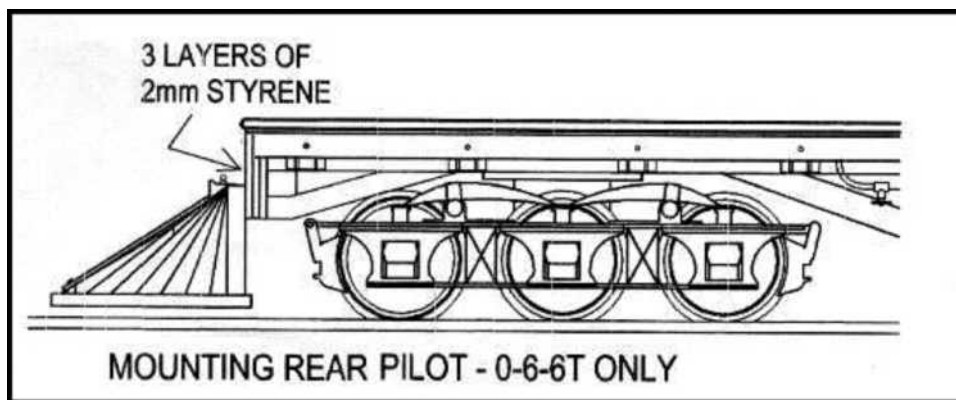

The construction method is somewhat like this funny diagram -sorry about that, but I ain't gonna make two pilots!



## Finishing up

In a coming chapter we'll be scratch making a dummy link and pin type coupler pocket for the rear end of the tender deck. But before we get to that, it'll be worth you testing what sort of coupler you intend to install on the rear, at what level above rail head, and at what placement. Depending on what type of coupler works for you, you might have to modify the dummy link and pin coupler pocket, or even simply not install the dummy coupler pocket at all. I should re-emphasize that the Masons of the South Park were never in their life fitted with knuckle couplers, but you should use a coupler type on your model that works best for what you run. I will be installing a Delton type knuckle coupler to my prototype model (yeah I know, no loco is complete without at least one part having been made by Delton!). The coupler types and methods of installation for your model are too varied to cover here, but here are some things to consider:

### For Wider Radius Curves:

Body mounting the coupler to the underside of the tender deck rear is the most desirable. You might need to layer up some 2mm thick styrene squares to form a pad for the coupler to be fixed to. This pad can be bolted to the underside of the BBT frame. This type of coupler mount will not work very well for folks running 2ft radius curves. The overhang over the curves at the rear end of the loco is such that such a coupler would be outside the rails!

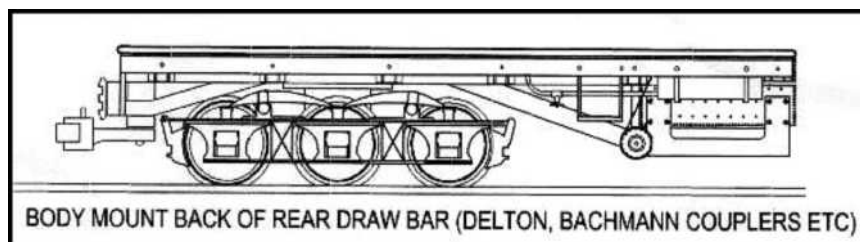
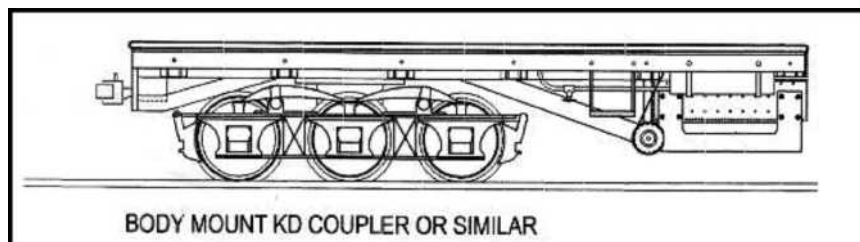

## For tight Radius Curves:

Mount the coupler onto a bar of either brass, or layers of 2mm styrene. With the coupler attached to one end of the bar, attach the bar to the BBT chassis in a location about 15mm to the rear of the tender truck pivot. This long type of coupler arm will enable good coupling of the loco to rolling stock, working on tight curves.

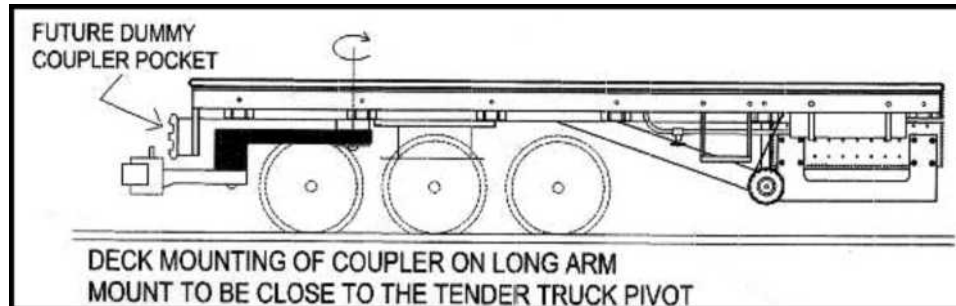

## Painting the Work of Chapter 2

We do not paint anything just yet. There are more assemblies to be attached to the cylinders, springs, and tender deck, and thus painting these assemblies now will only hamper that later work. This will also give you more time to think about how you want your Mason Bogie to look.

At this time the chassis spring unit is still not attached to the frame, and the pilot assembly and tender deck assembly can be unbolted for future spray painting. This is how it is meant to be! Here we come to the end of Chapter 2. There that wasn't so hard now was it? At this time, your loco is about 1/6th complete! Also, in this chapter you've had a taste for the kind of work required to build the whole loco. It doesn't get any harder than this, nor any easier. This is the standard of work to expect.

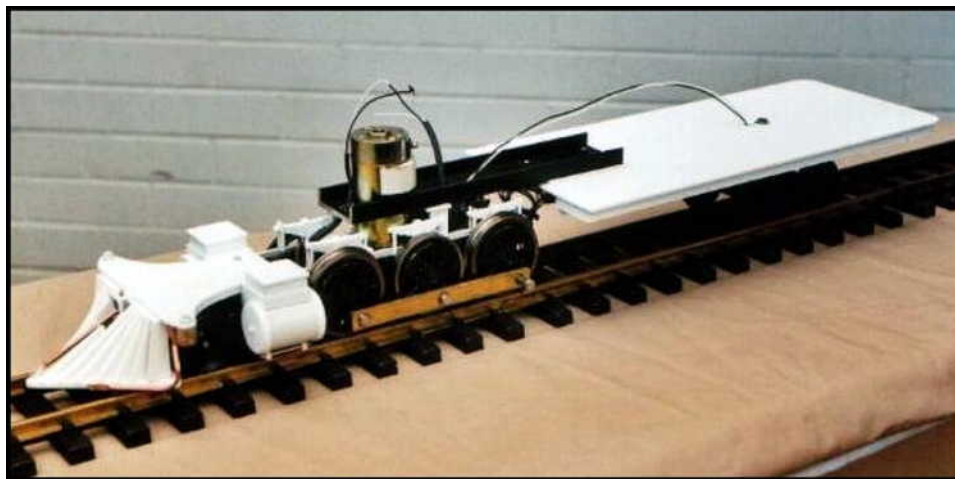

The MasterClass 2002 Mason Bogie chassis as seen at the conclusion of Chapter 2.

Here endeth the lesson.

Good Luck, and enjoy the modeling.

David Fletcher

July 2002.

## **Acknowledgements:**

As you know I'm not doing this all on my own, Specifically I'd like to acknowledge the help provided for this chapter.

A big thanks to Wes White for his fine work in pulling together and writing the chapter about Mason Colors. A huge thanks to Jerry Kitts, and Doug Heitkamp for this fine research work in defining the color schemes. Also to Rob Sloan, for use of his color assessments that had for a very long time been recognized as the Mason colors.

I want to hear three cheers for Scot Lawrence for his Photoshop renderings of the Mason color schemes, I've never seen such vivid expressions of what a model might look like, without having to build or paint an actual model -amazing work Scot.

We are indebted to George Sebastian Coleman for his on-going work in overseeing our model designs, to ensure that what we are building is a true and fair representation of the prototype. There are things in the Mason that one cannot properly be discern from drawings alone, nor by looking at a bunch of photos. This is where George's experience, collection of prototype data and pure love of the locomotive is of assistance to us all.

Big thanks to Tom Farin for maintaining and up-dating the Mason Bogie Archive:

<http://www.ironhorse129.com/>

Keep sending those Mason Bogie Photos in!

A huge thanks to Vance Bass also for use of his eagle eye. He has proof read all the construction section and drawings, as well as providing the option of wood pilot and cab kits. Should you find any typos or errors, you can be sure its not his fault, because I keep adding stuff, that he might not have read!

Barry Olsen is central to the project as you know, and as you read this, you can be sure he's out there in his workshop, his days like crazy paving looking after each of you.

Thanks to Shad Pulley for getting all this on-line!